

IDEA - 50044

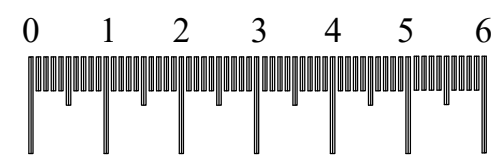

0001K	13x	0011K	2x	0005V	8x	0008K	8x	0010K	6x
8x40				7x50				M4x20	
0013K	1x	0016K	25x	0015U	3x				

1.)

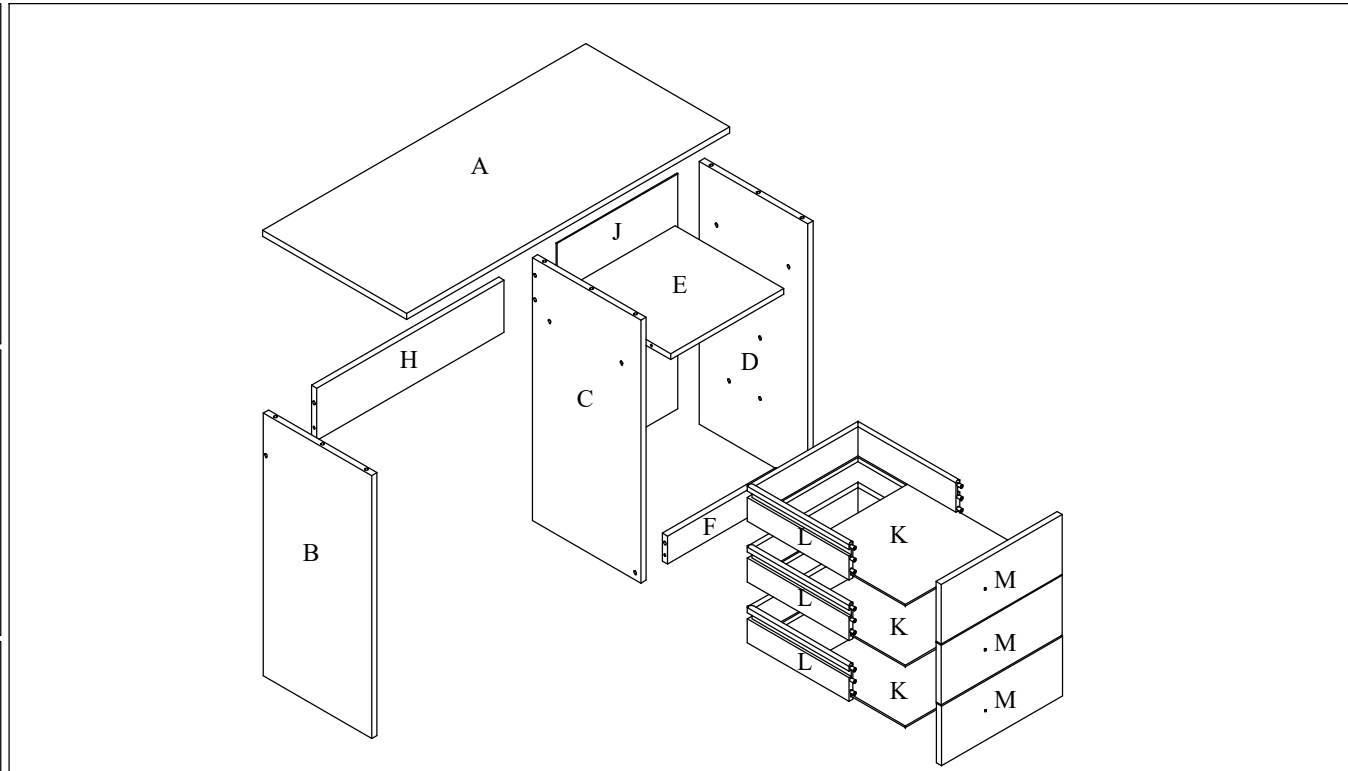
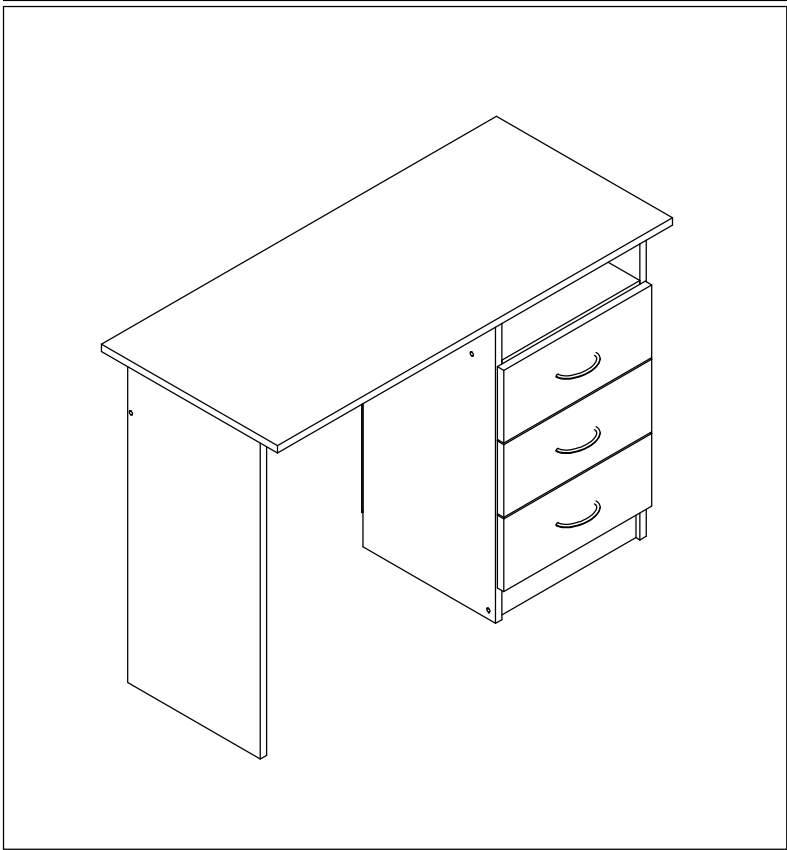
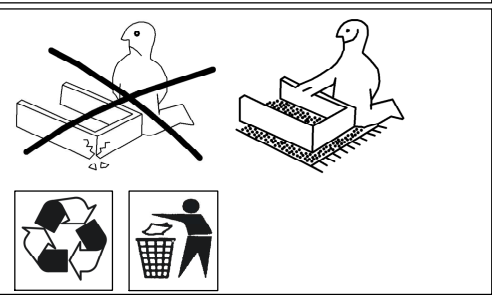
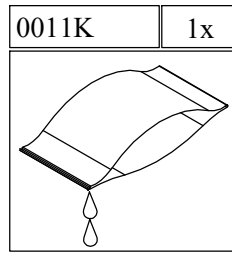
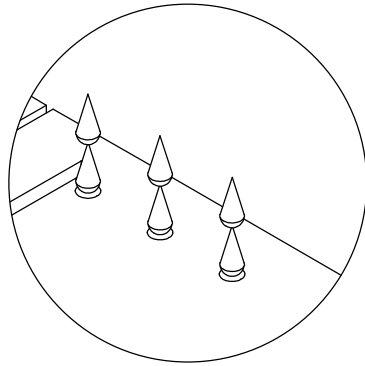
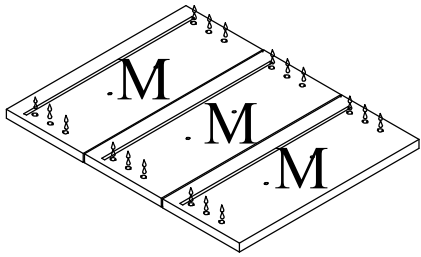

3.)

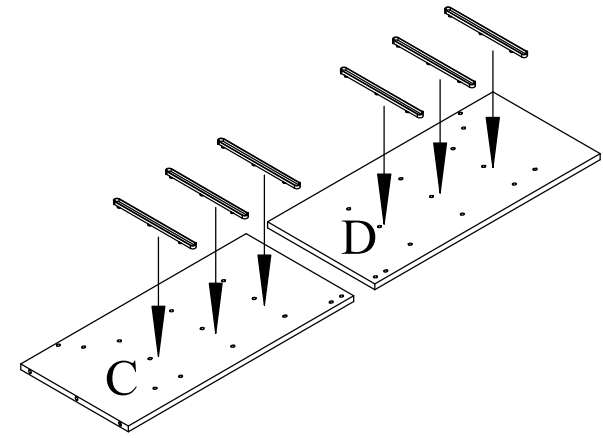

2.)

I.)

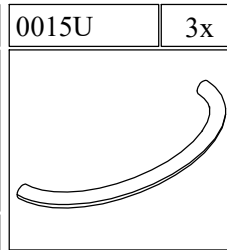
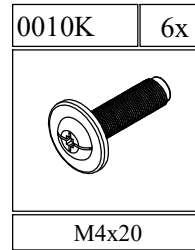
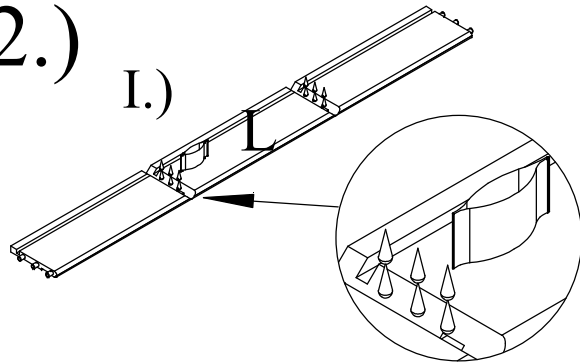

II.)

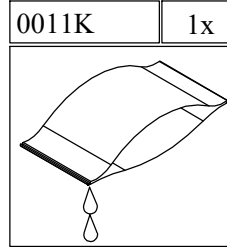
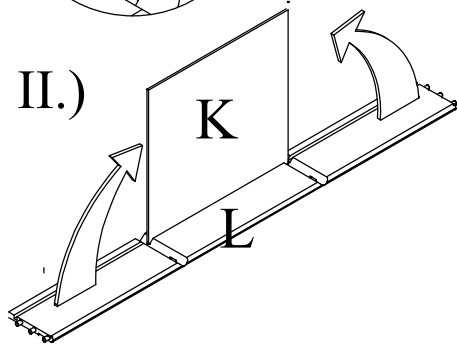

III.)

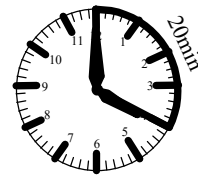
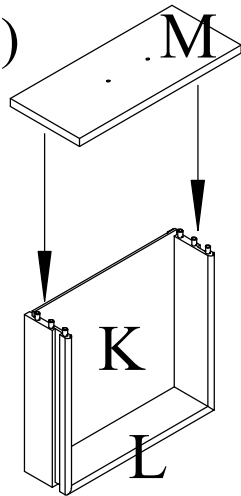

IV.)

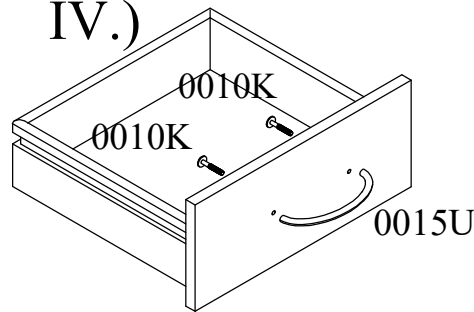

4.)

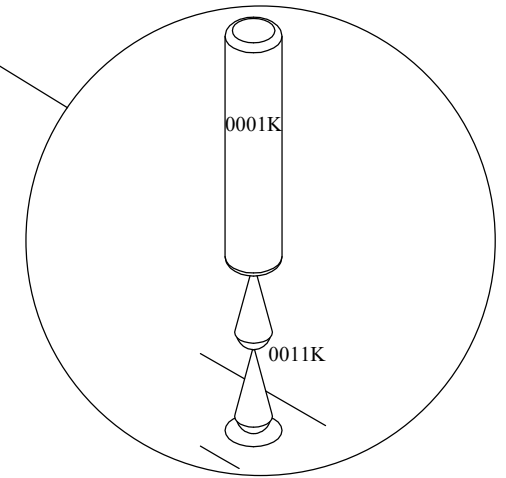
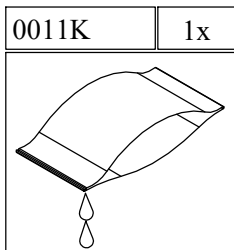
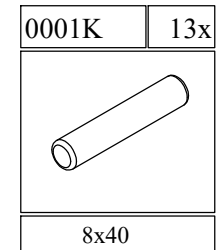
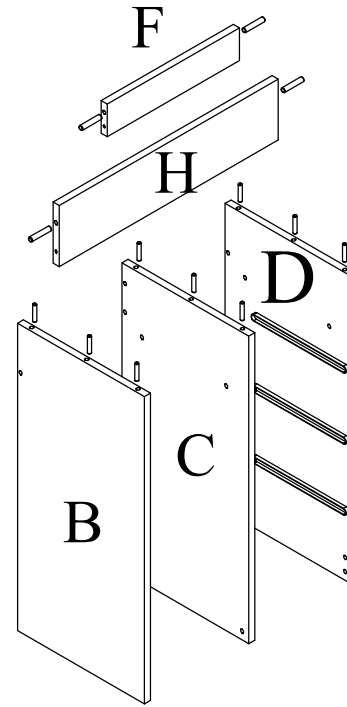

5.)

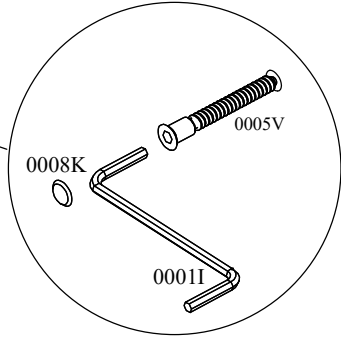
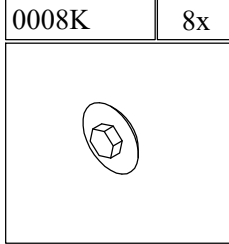
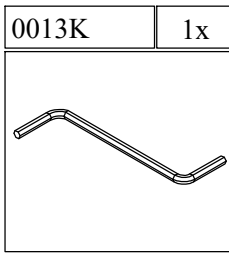
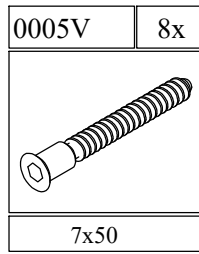
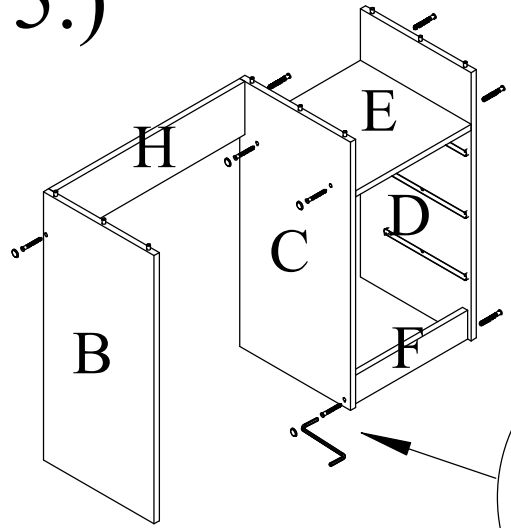

7.)

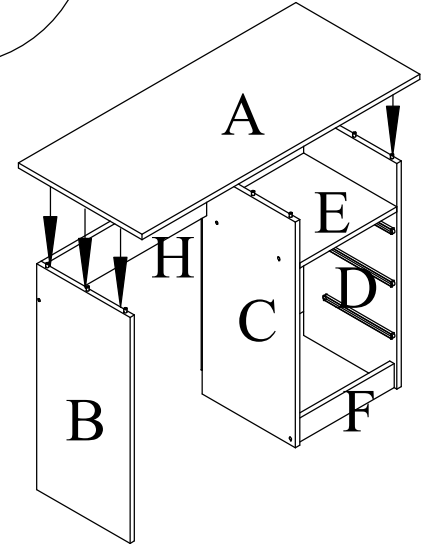
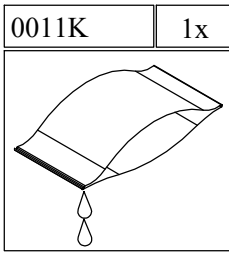
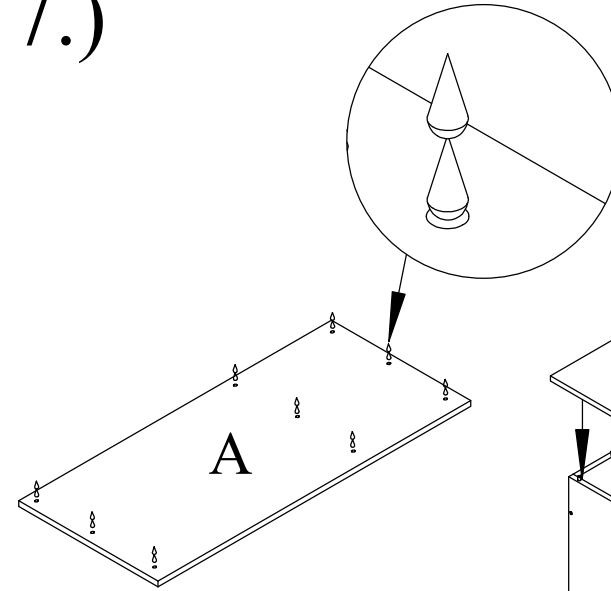

6.)

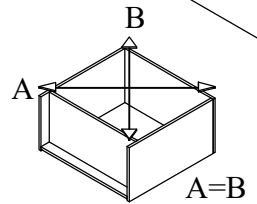
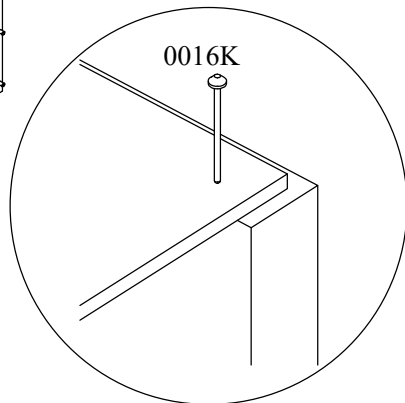
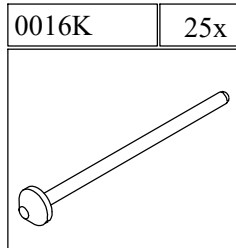
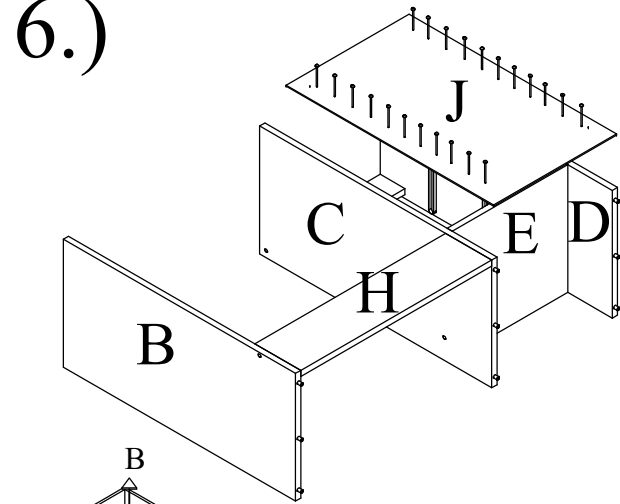

8.)

