

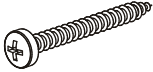

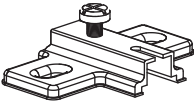

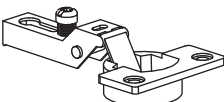

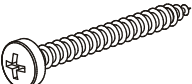

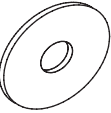
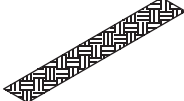

A x 34  8,0 x 30mm	B x 61  3,5 x 30mm	C x 06  12 mm	D x 09  	E x 16  4,0 x 40mm
F x 02  	G x 40  	H x 02  	I x 01  	J x 39  4,0 x 16mm
L x 03  	M x 02  	N x 02  	O x 08  3,0 x 16mm	P x 03  7 mm
Q x 16  				

1

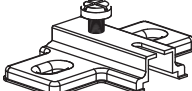

A x 34

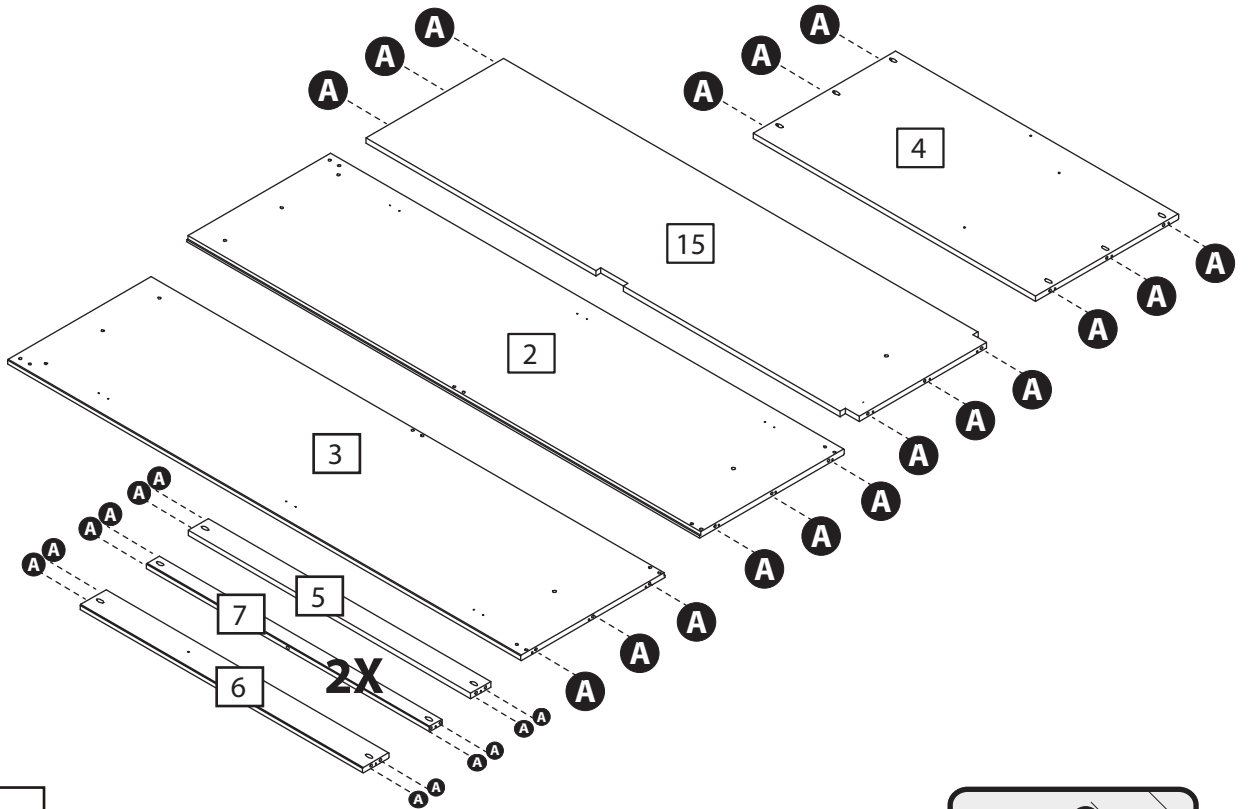
8,0 x 30mm

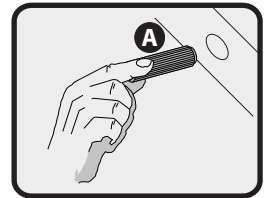

2

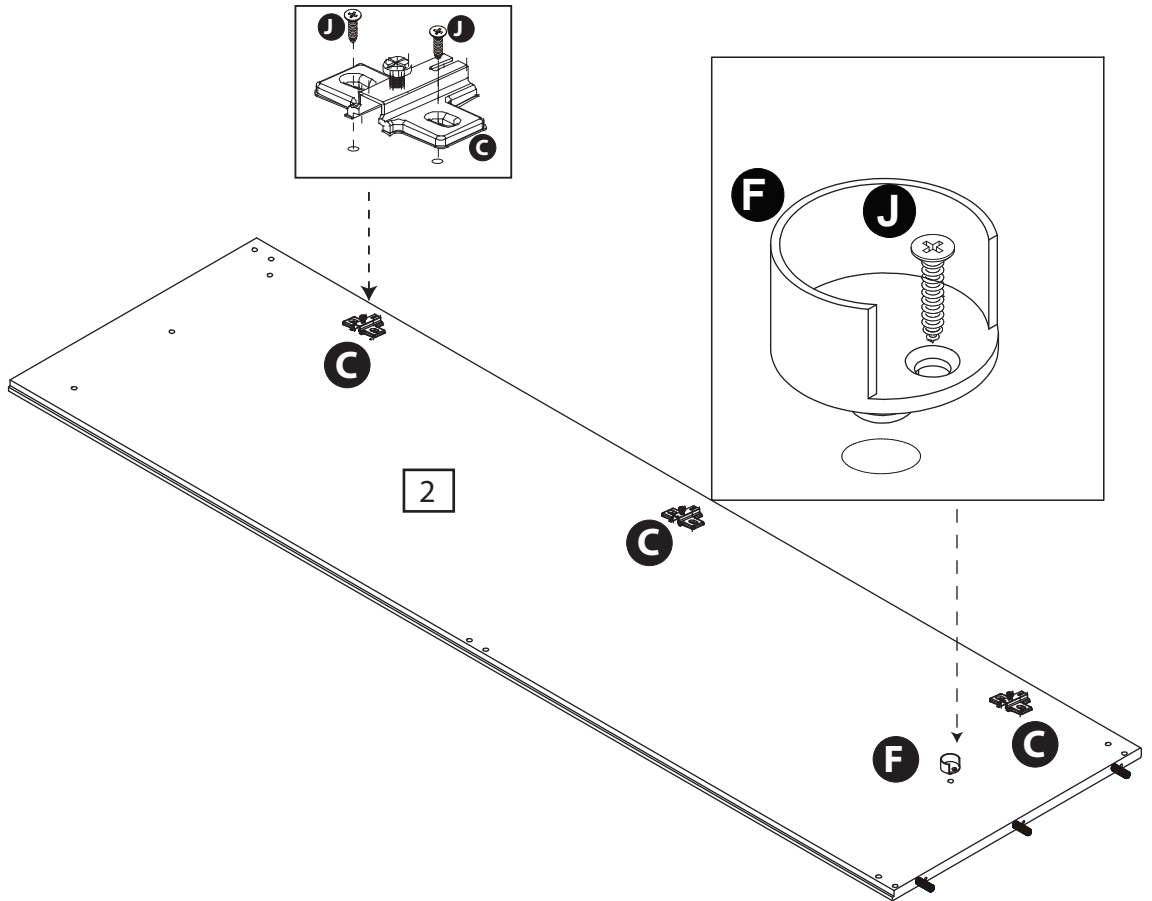

F x 01

J x 07

4,0 x 16mm

C x 03

3

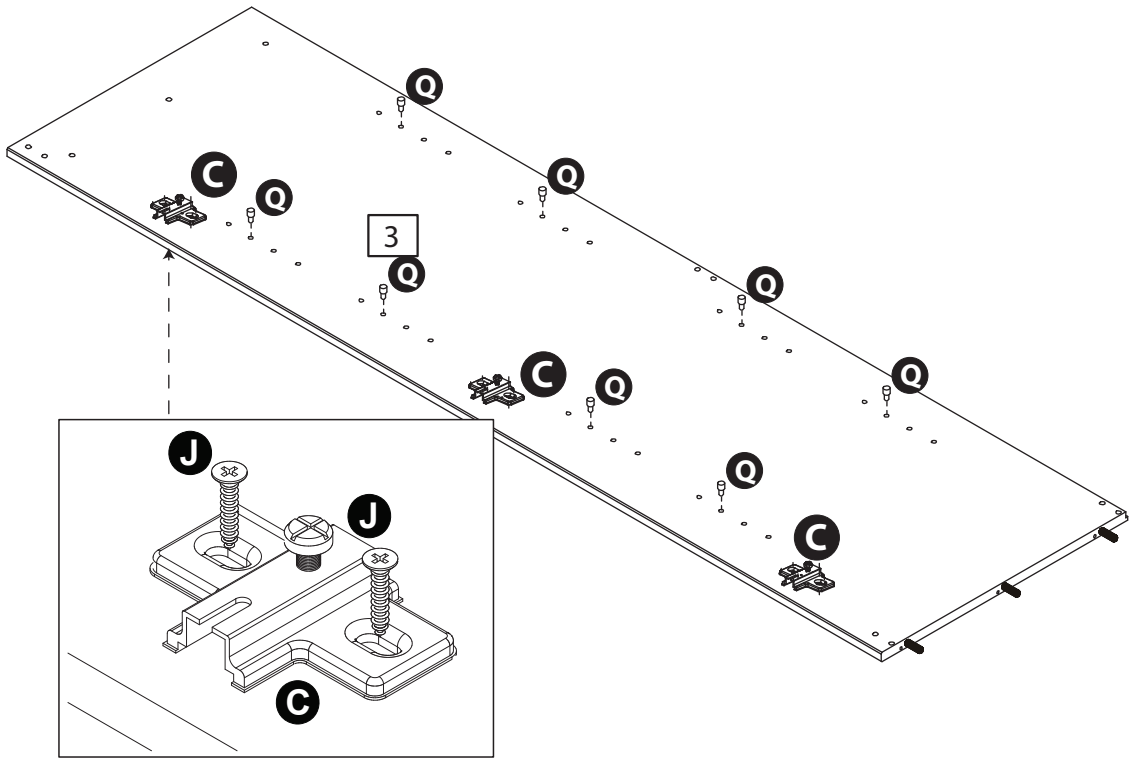

Q x 08

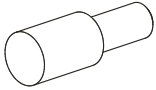

J x 06



4,0 x 16mm

C x 03

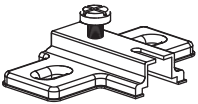

4

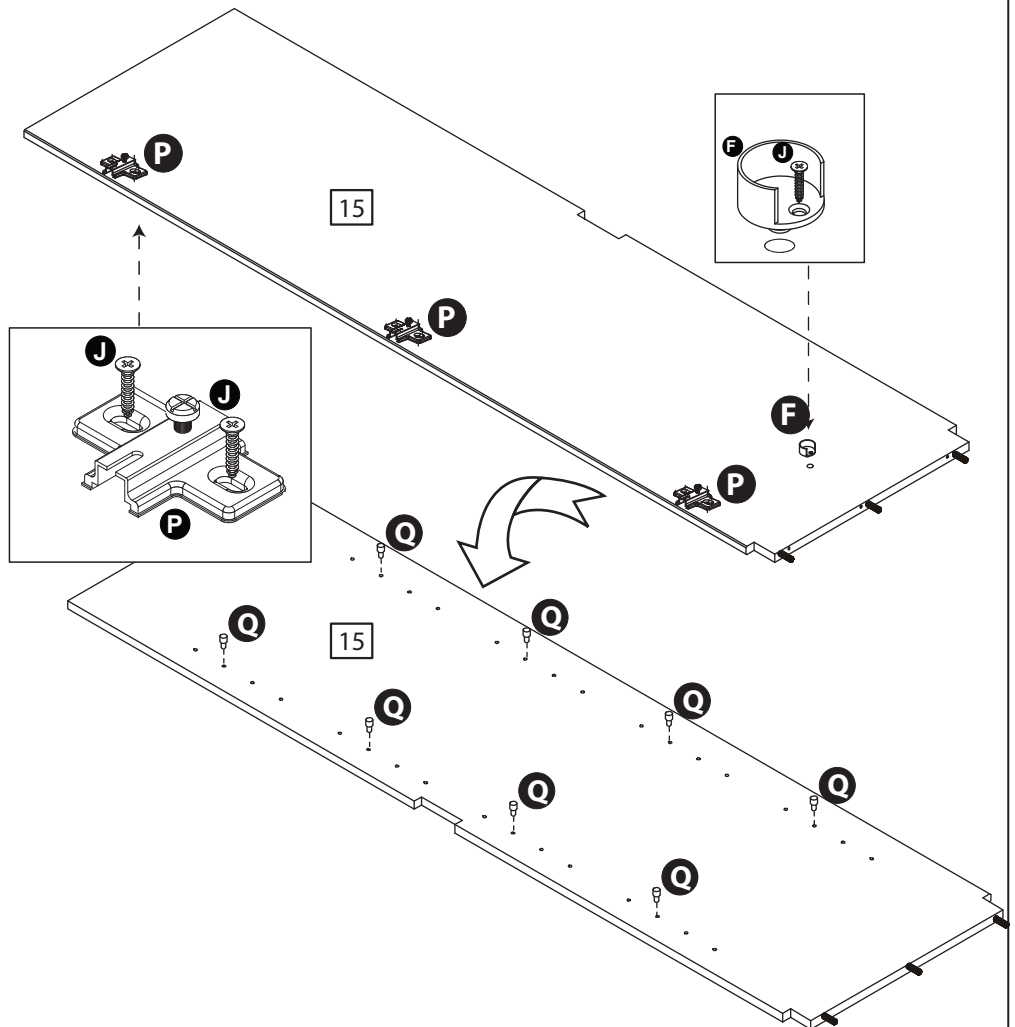

F x 01



Q x 08

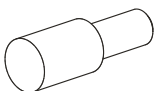

J x 07



4,0 x 16mm

C x 03

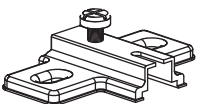

5

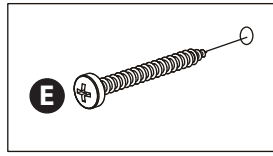

2X E

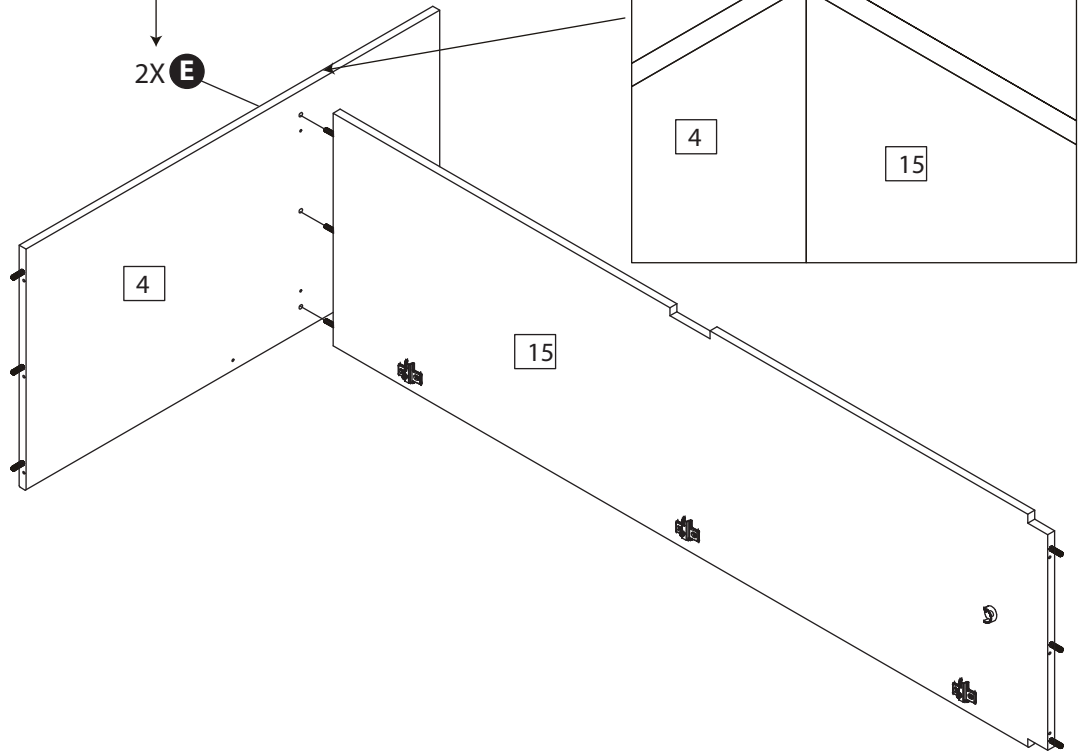

E x 02

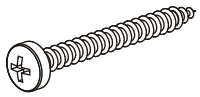

4,0 x 40mm

6

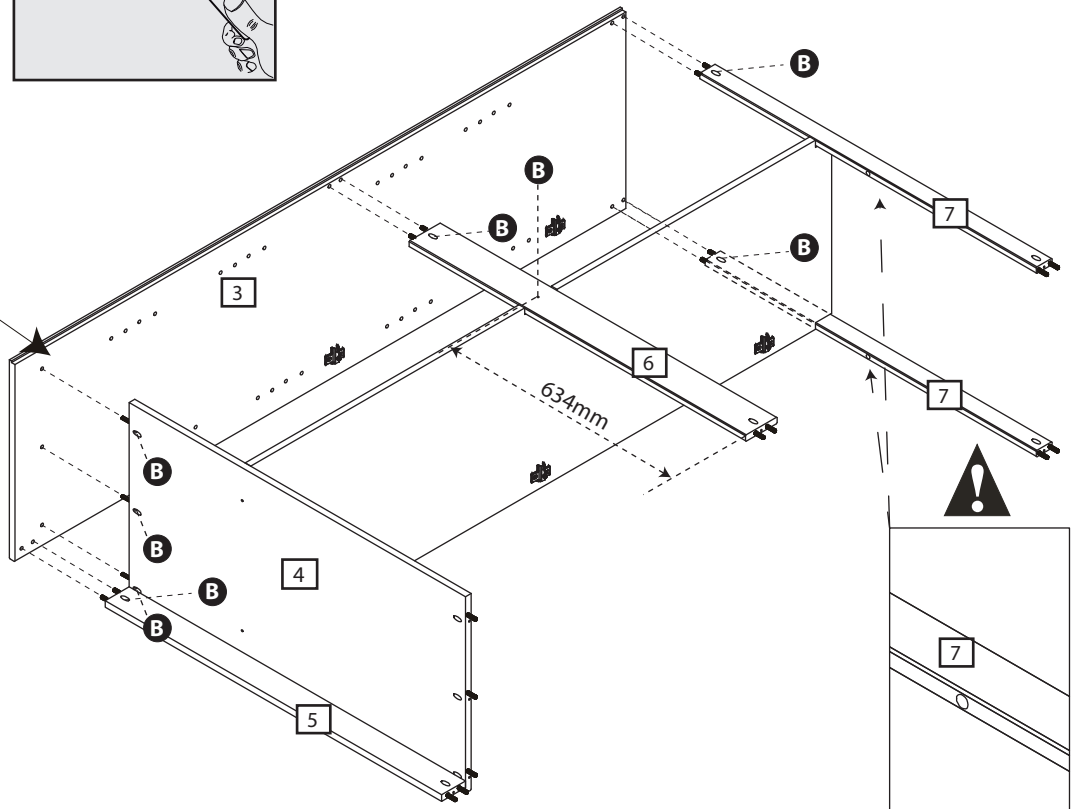
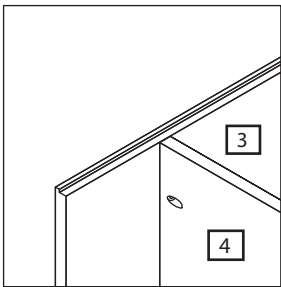
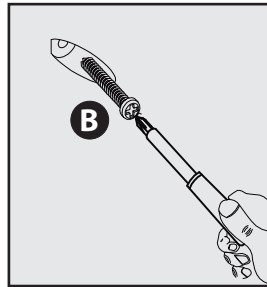

B x 08

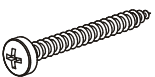

3,5 x 30mm

7

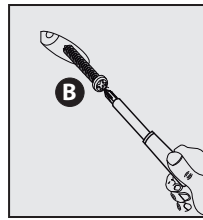
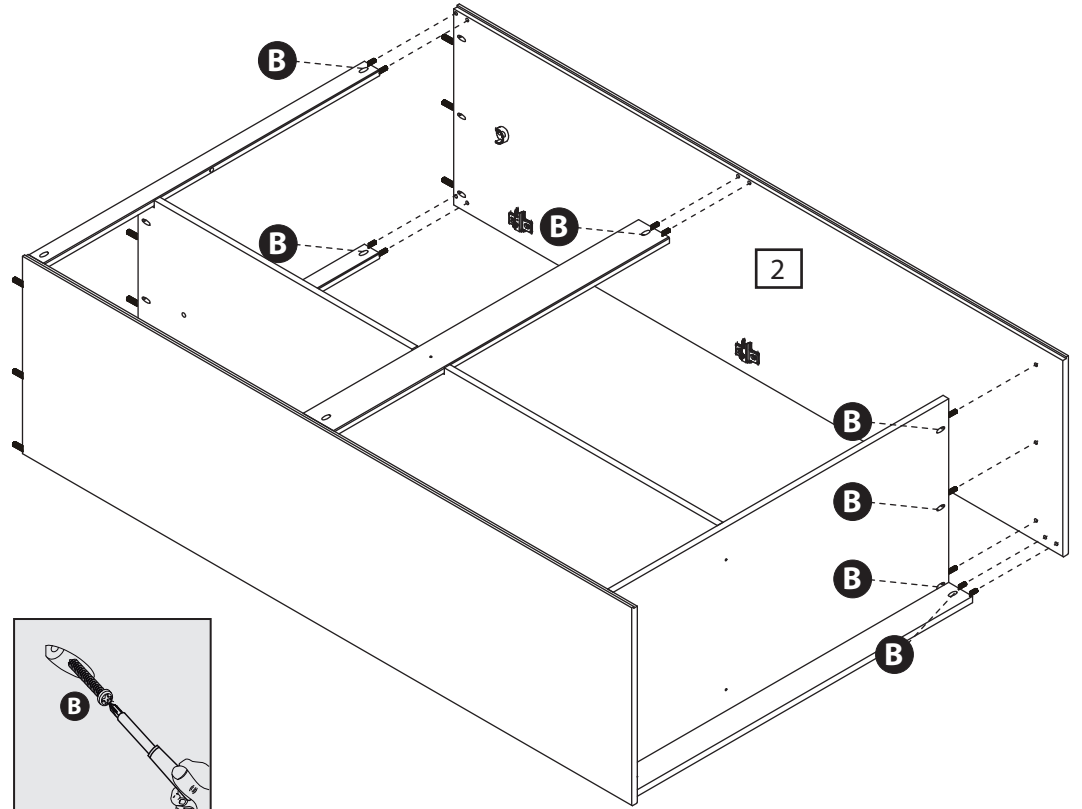

B x 07



3,5 x 30mm

8

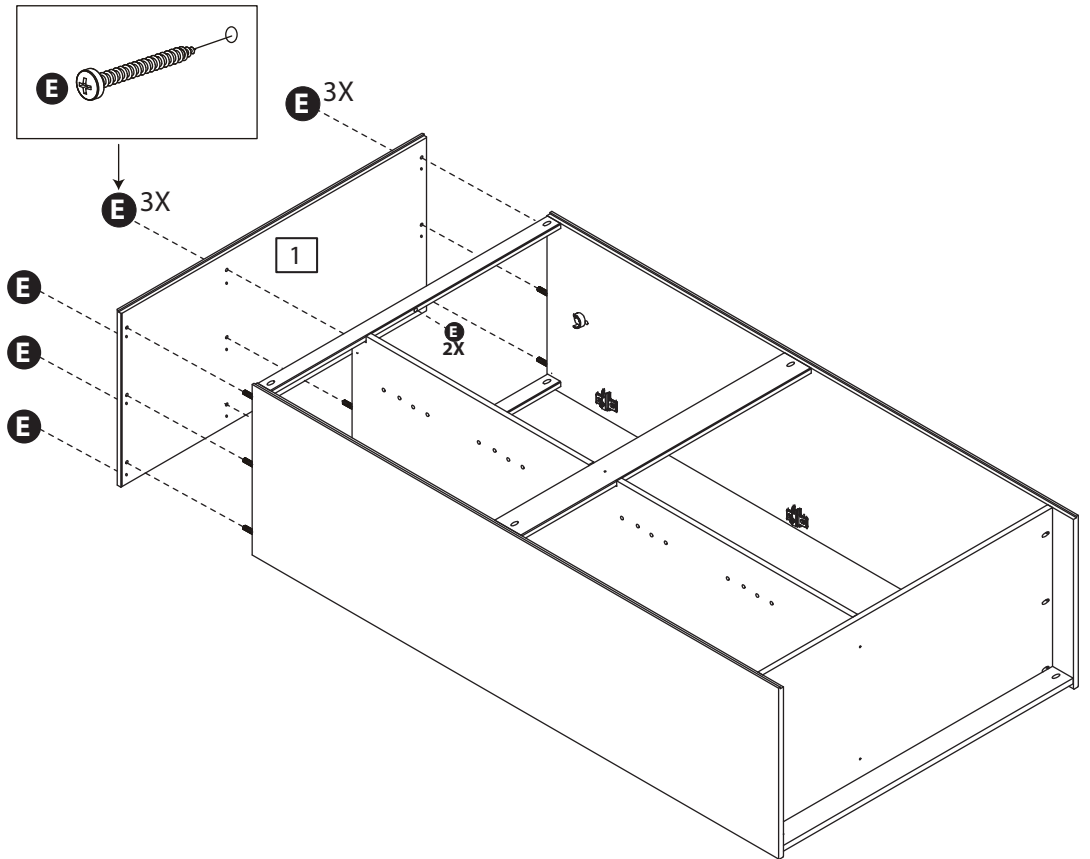

E

E 3X

E 3X

1

E 2X

E

E

E

E x 11

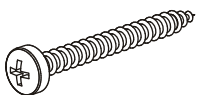

4,0 x 40mm

9

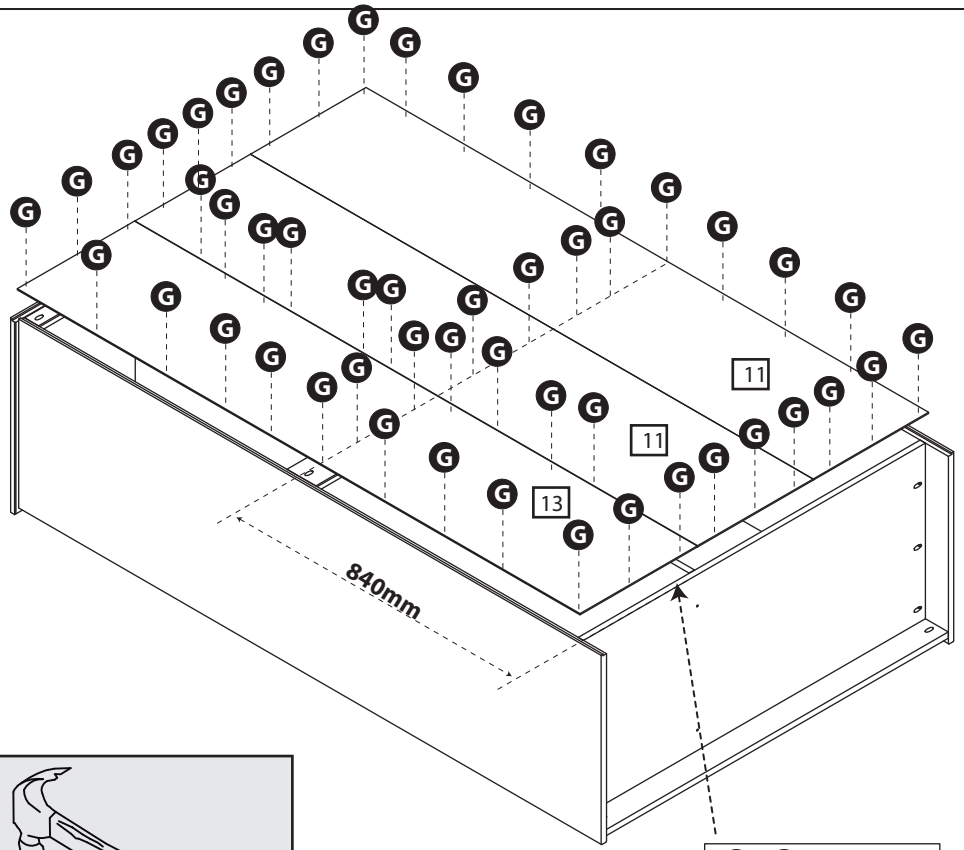
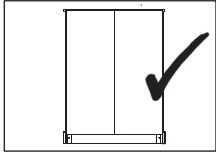
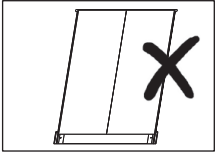

G x 40

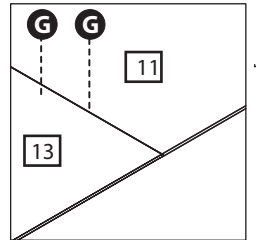
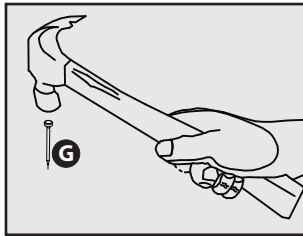
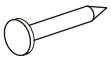

10

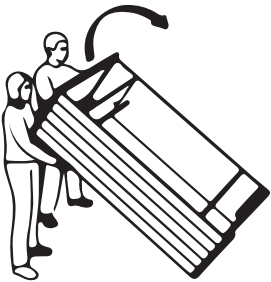

B x 01

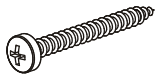

3,5 x 30mm

M x 02

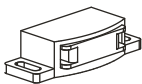

O x 04

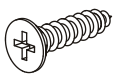

3,0 x 16mm

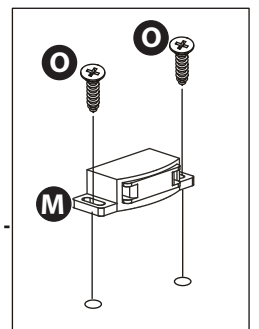
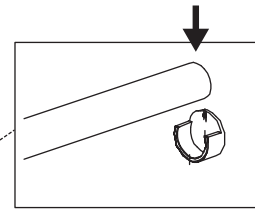
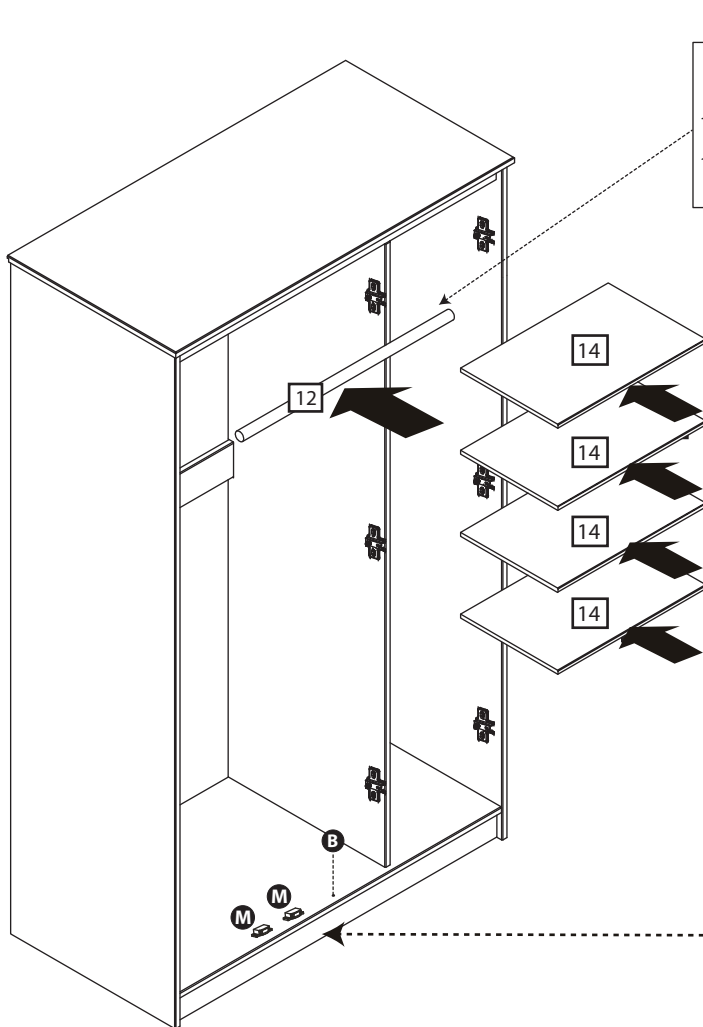

11

3x

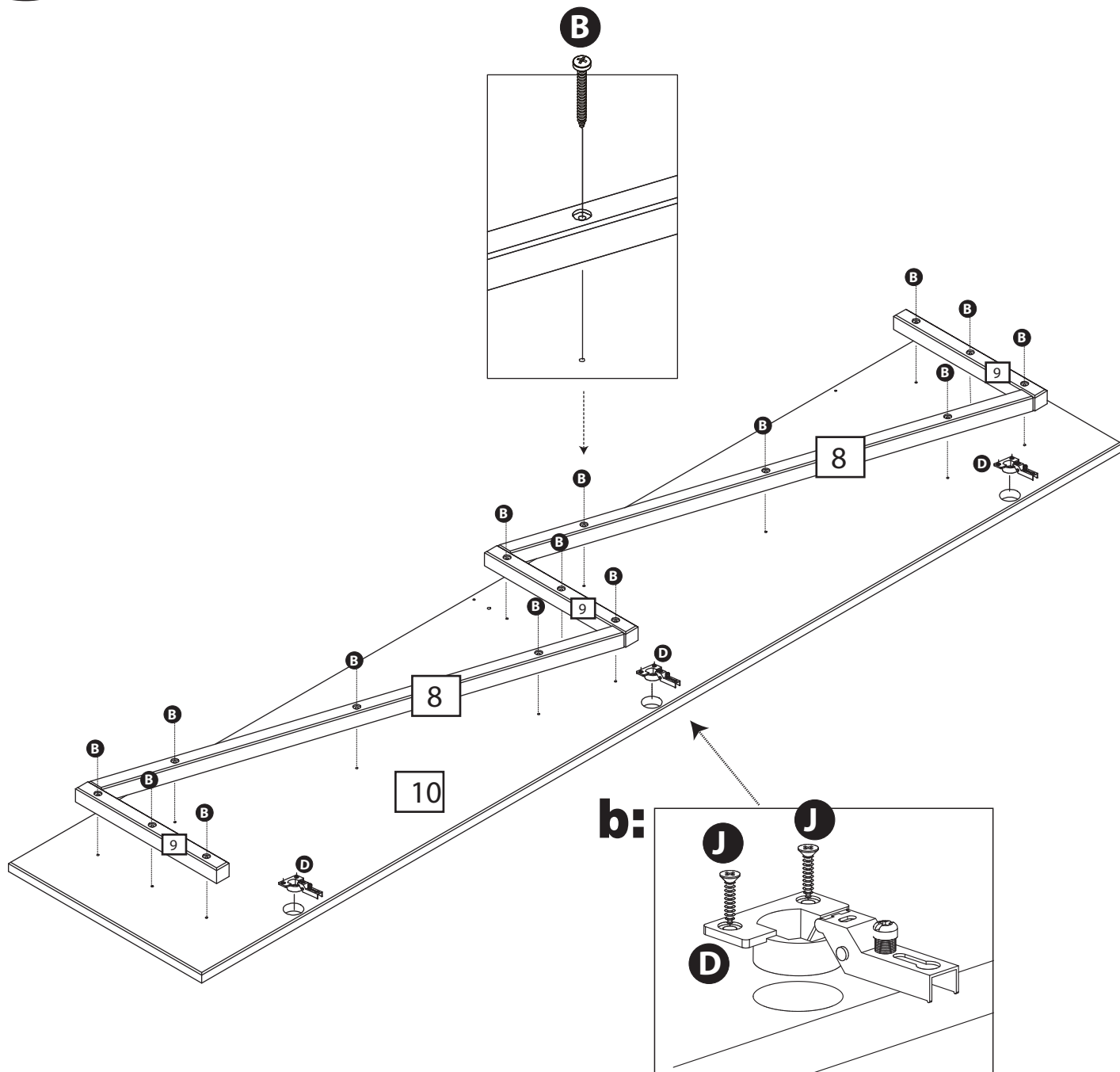

J x 18



4,0 x 16mm

D x 09

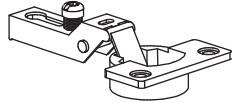





B x 45

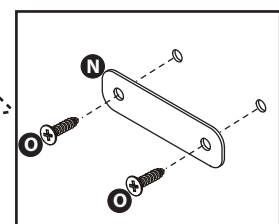
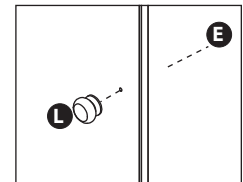
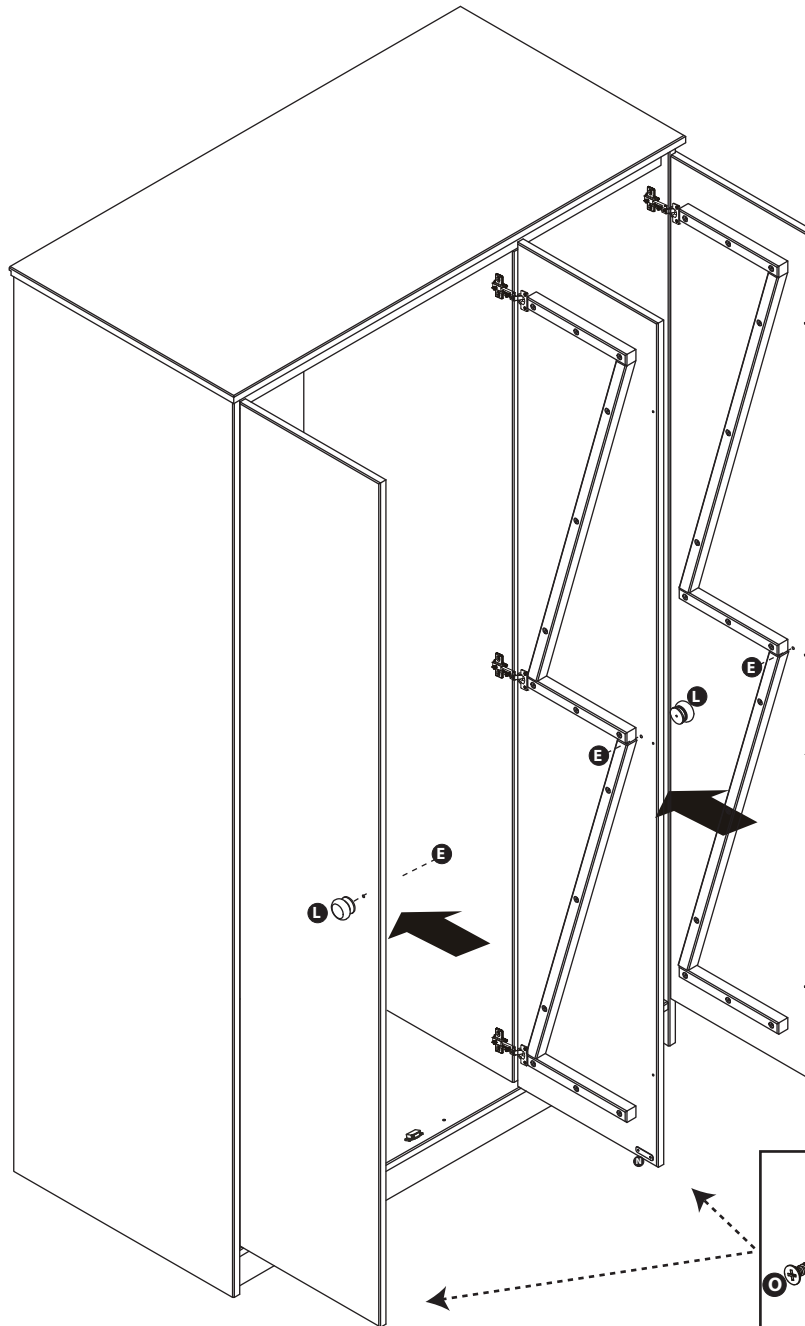
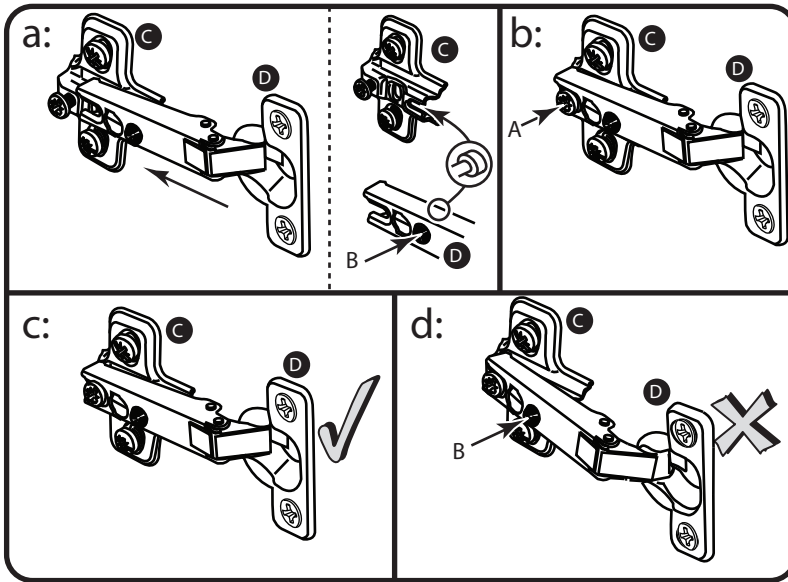

3,5 x 30mm

12

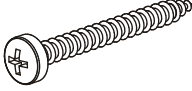

- O x 04**

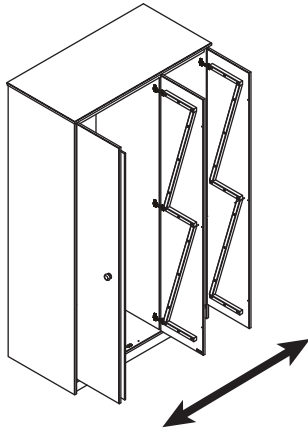
3,0 x 16mm
- L x 03**

- E x 03**

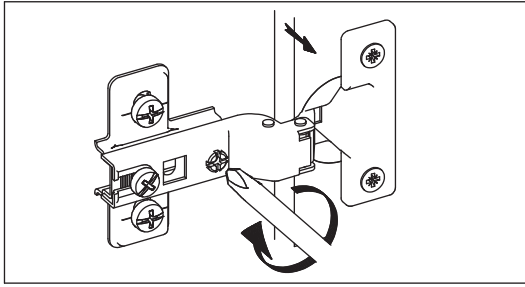
4,0 x 40mm
- N x 02**

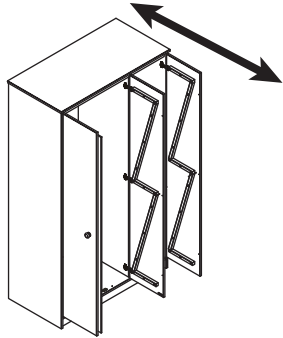
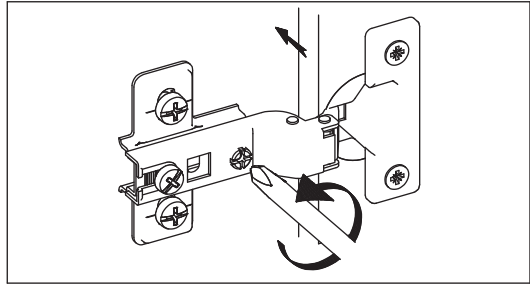

a:



b:



a:

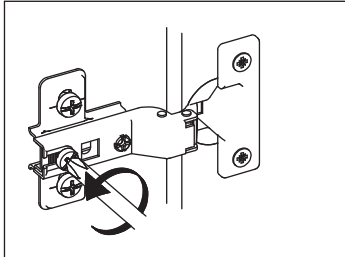

b:

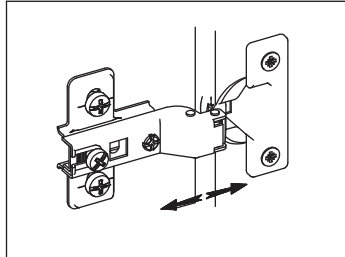

c:

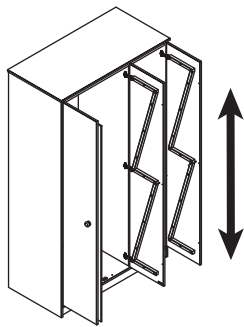
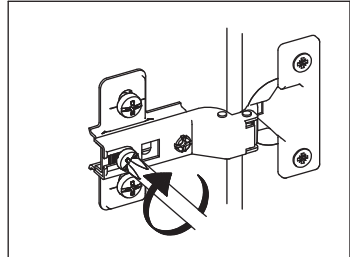

a:

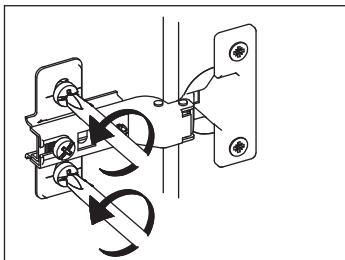

b:

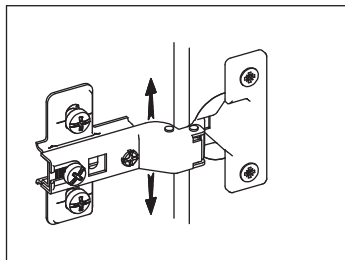

c:

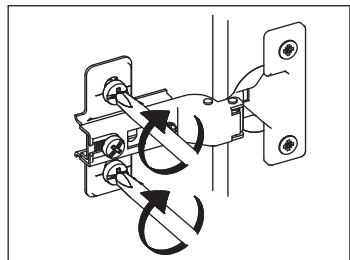

14

