

16313

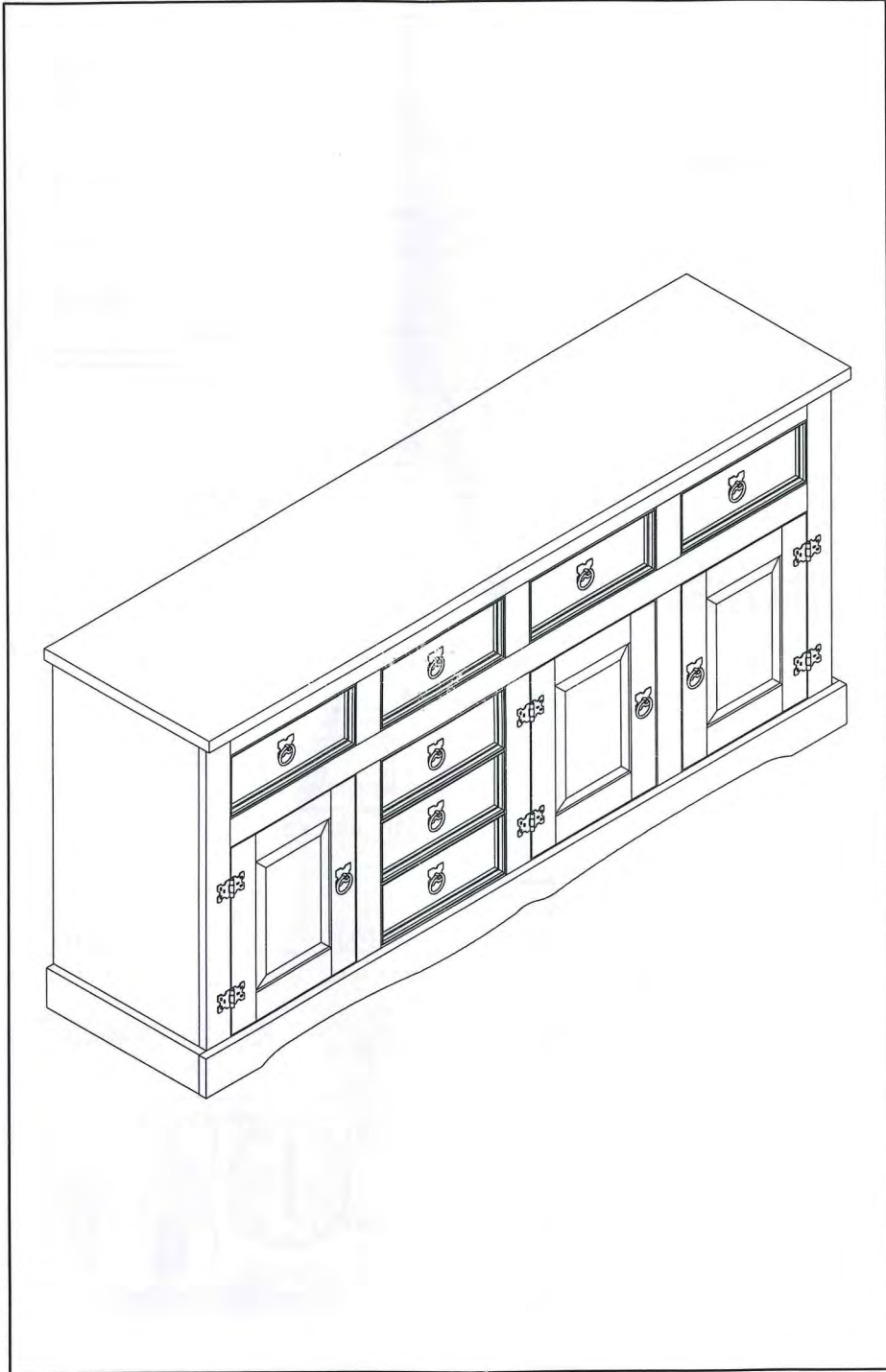

Ref.: 534

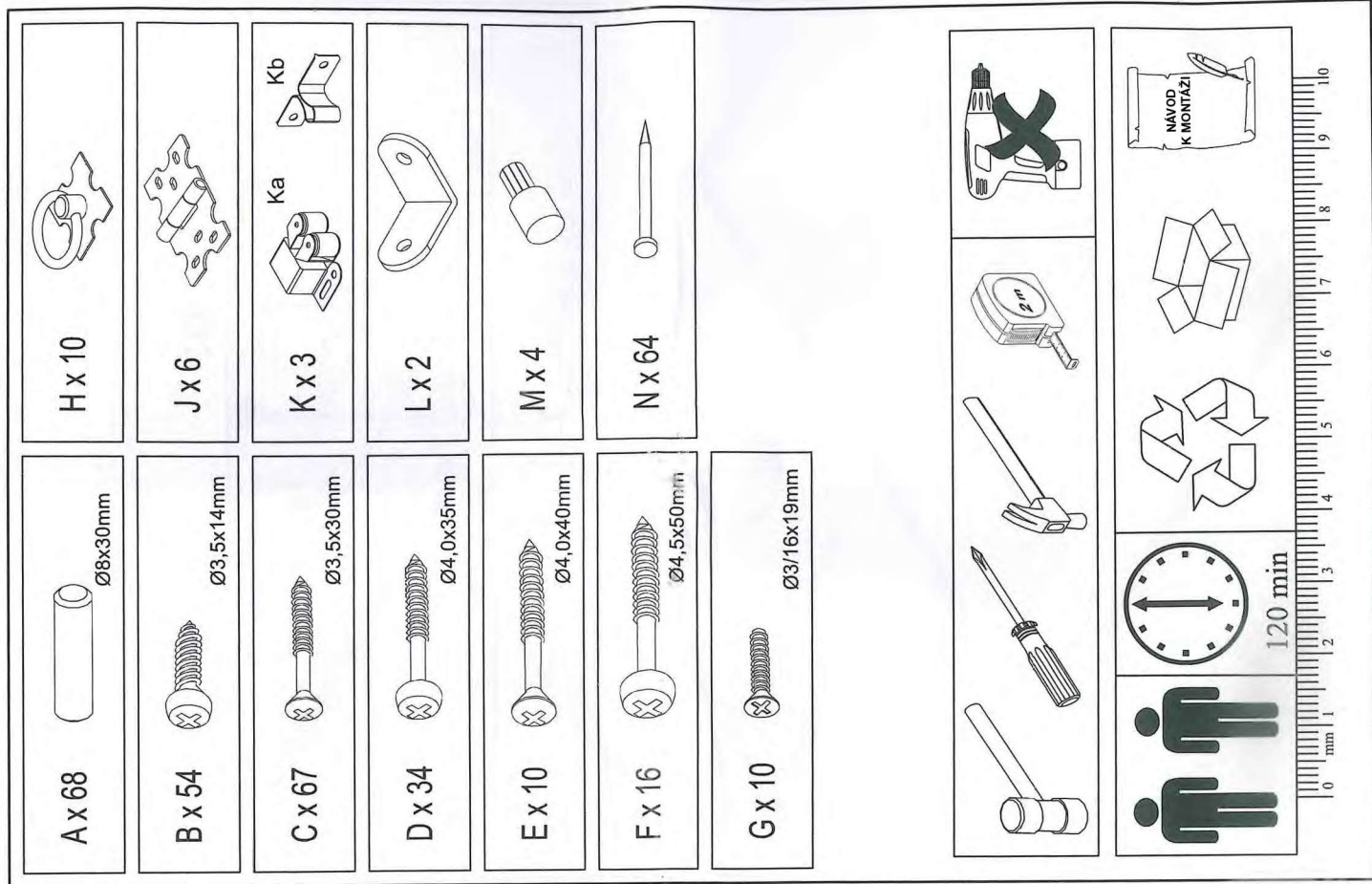
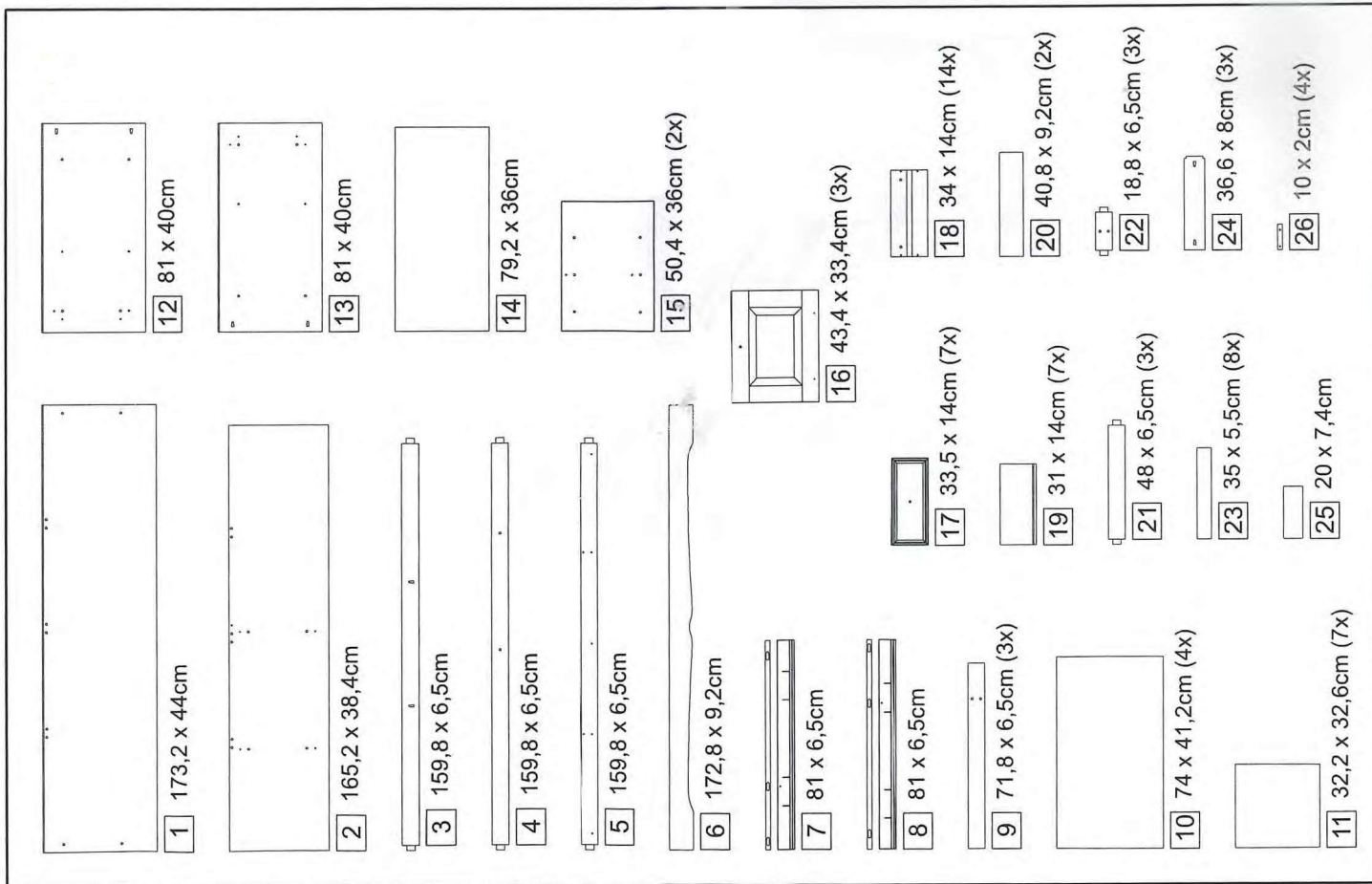

1

a:

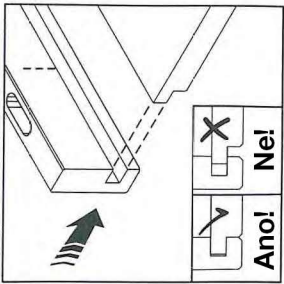

b:

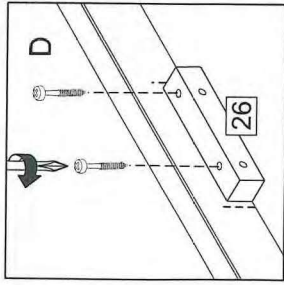

c:

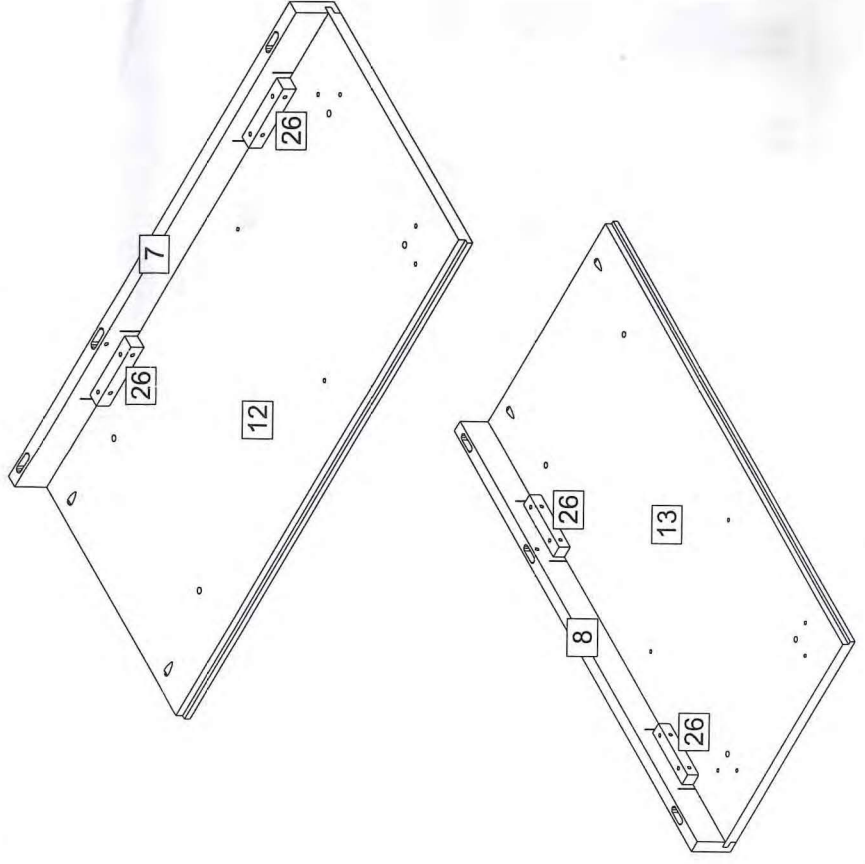
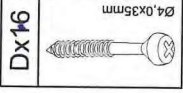
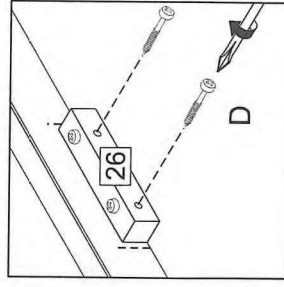

2

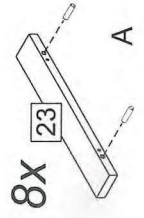
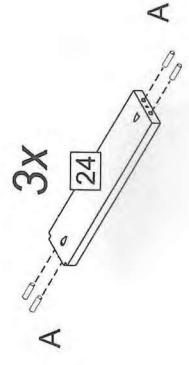
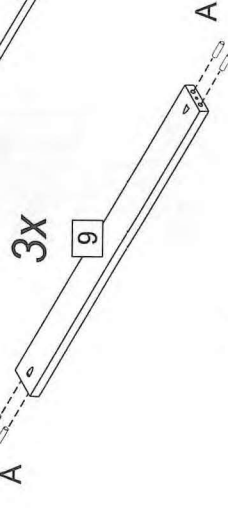
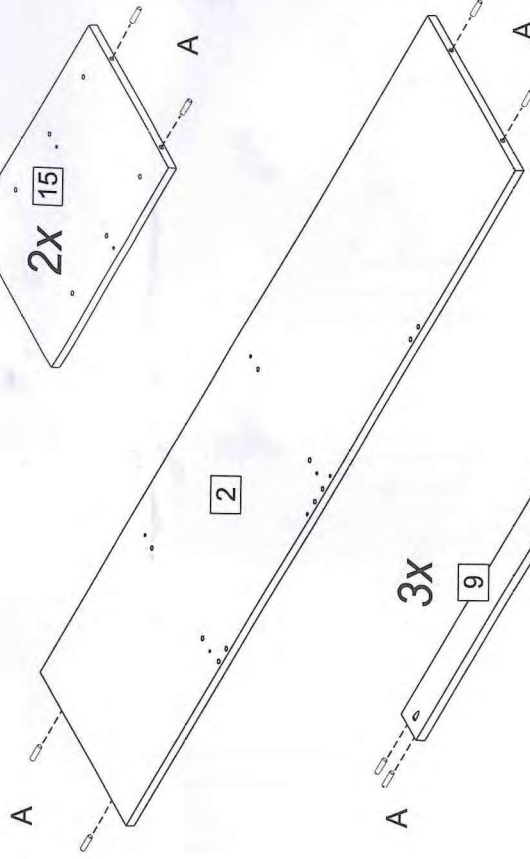
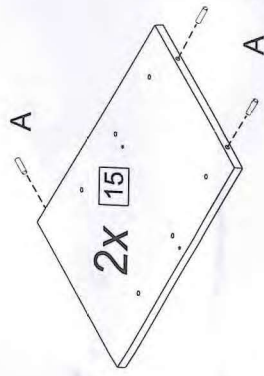
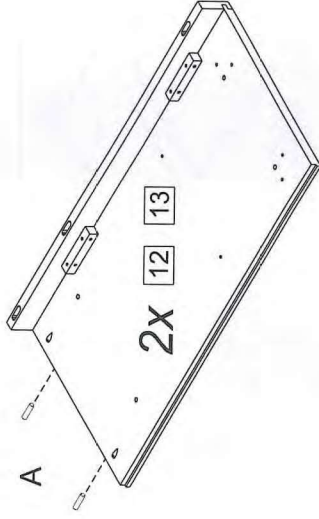
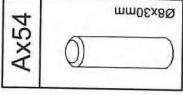

5

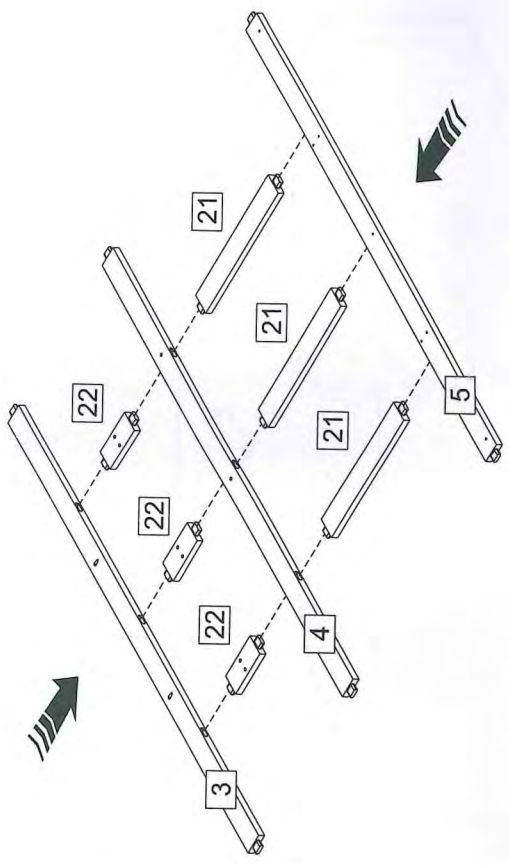

6

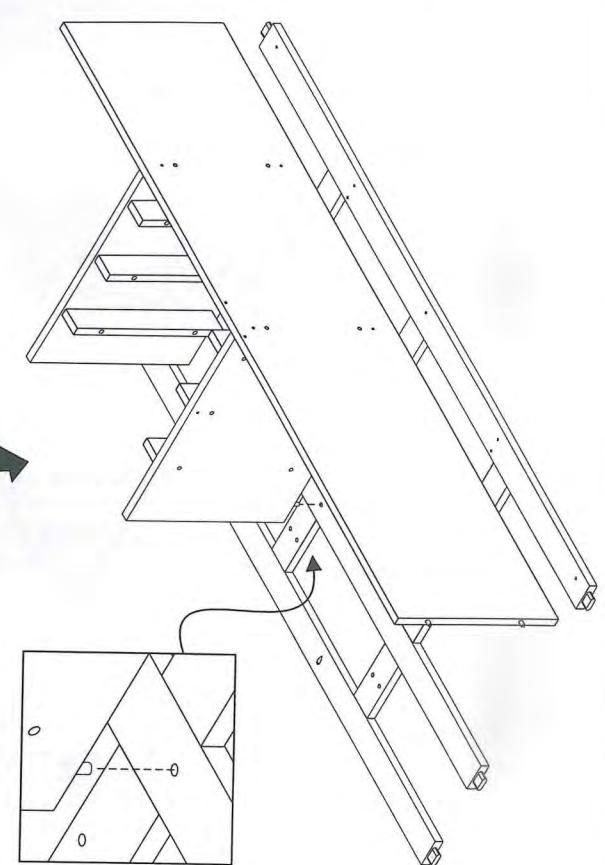

3

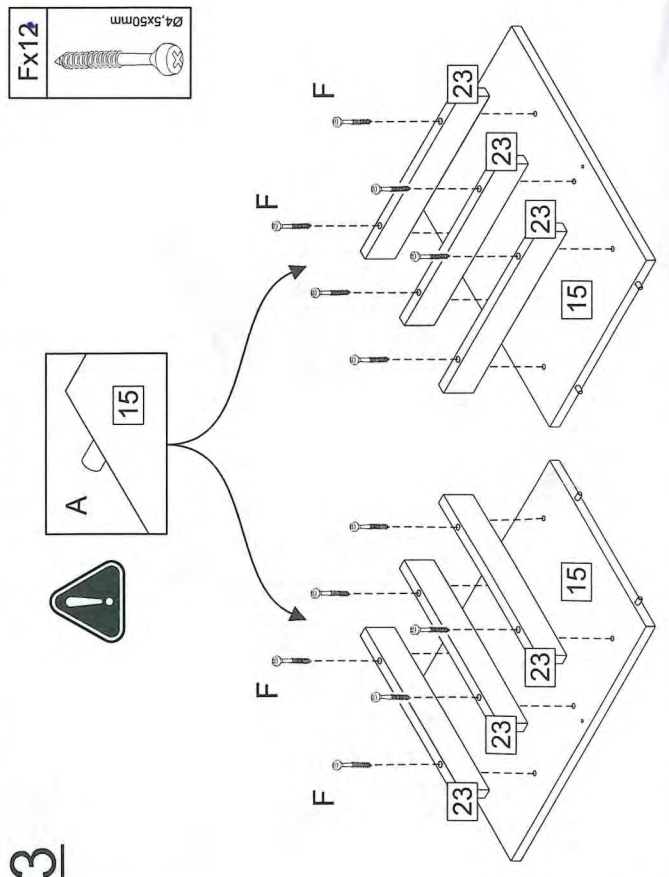

4

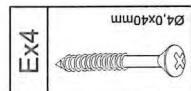
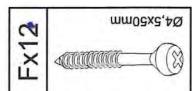
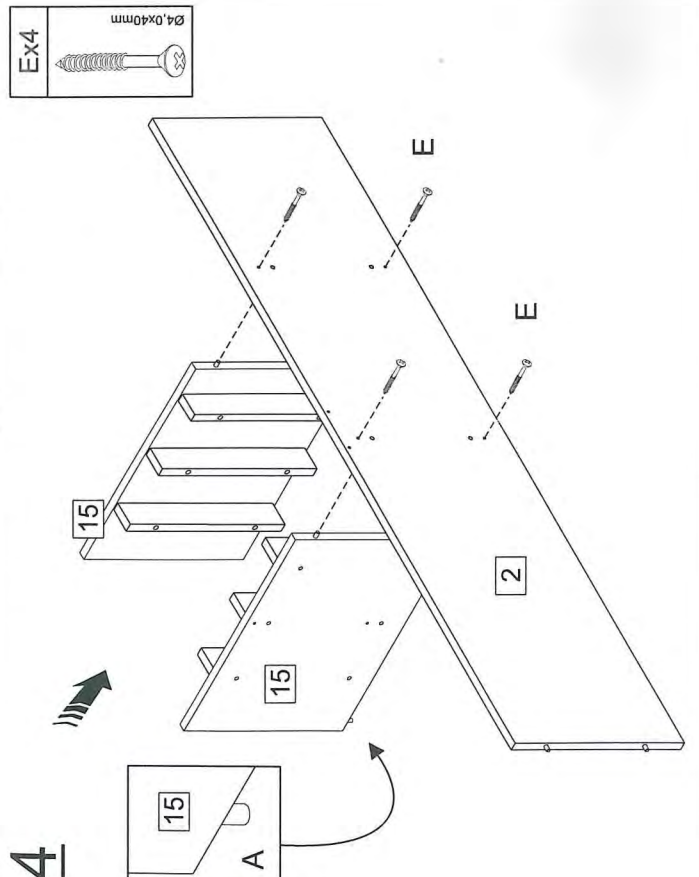

7

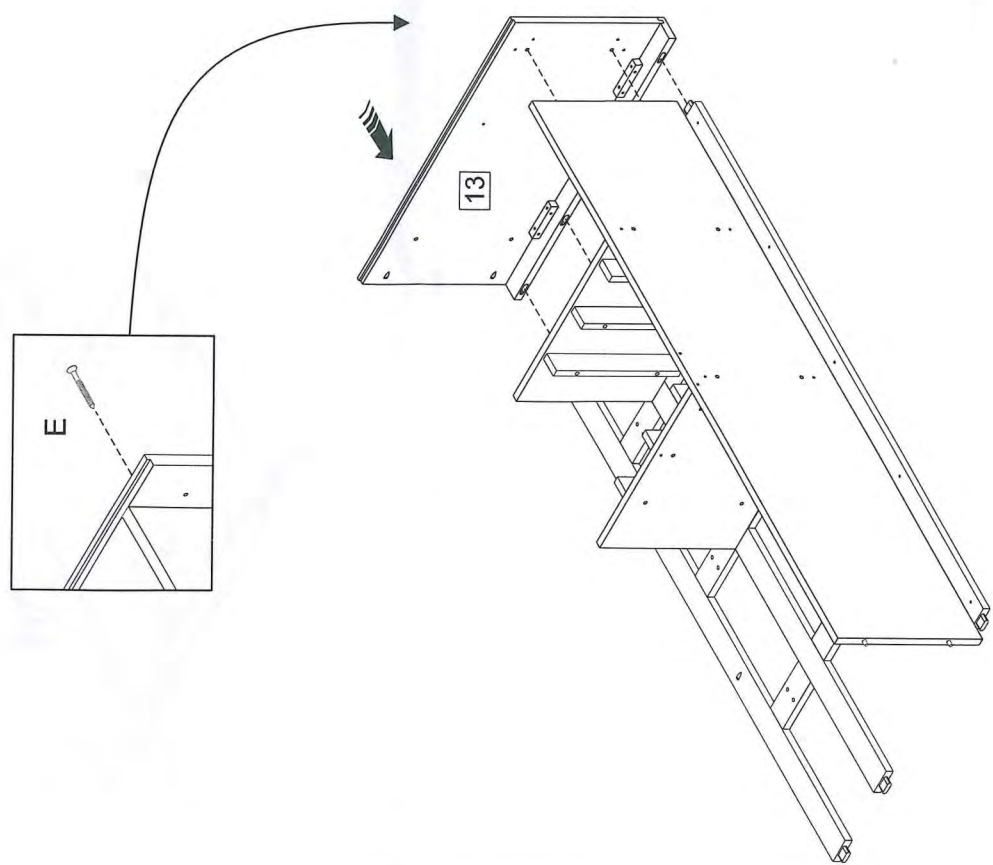
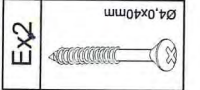

8

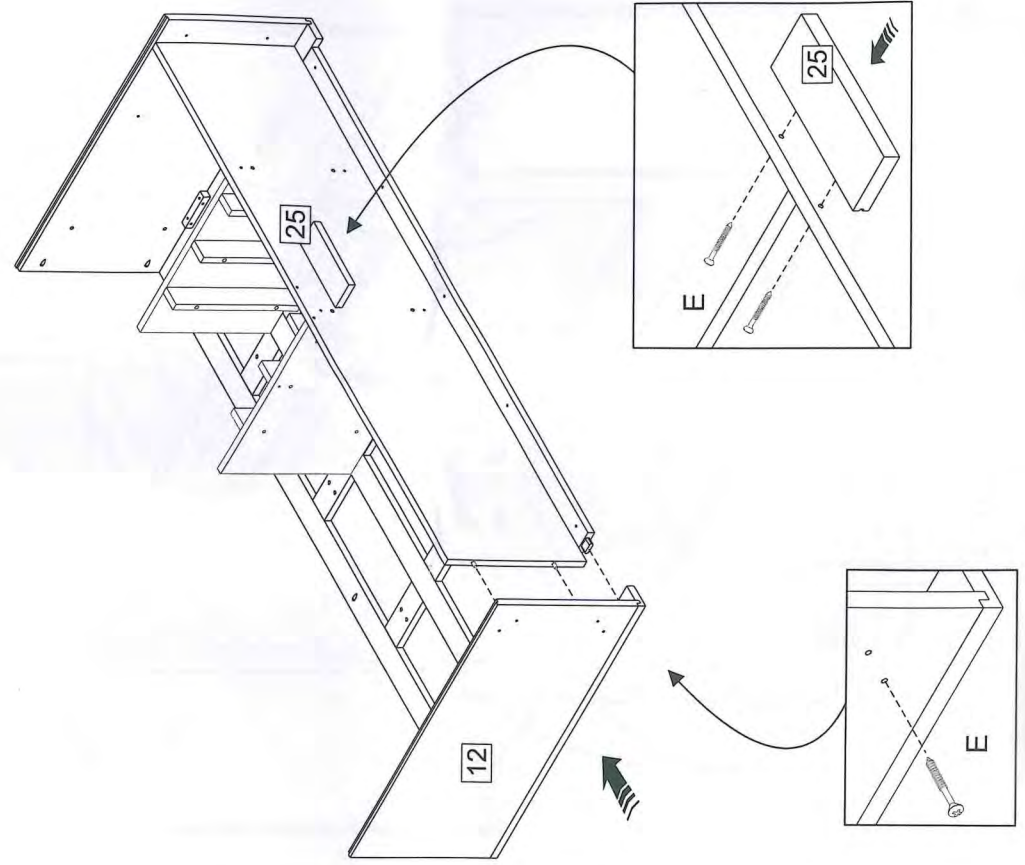
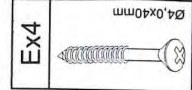

9

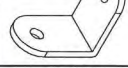
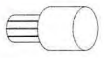
Bx6	Lx2	Mx4
		
Ø3,5x14mm		

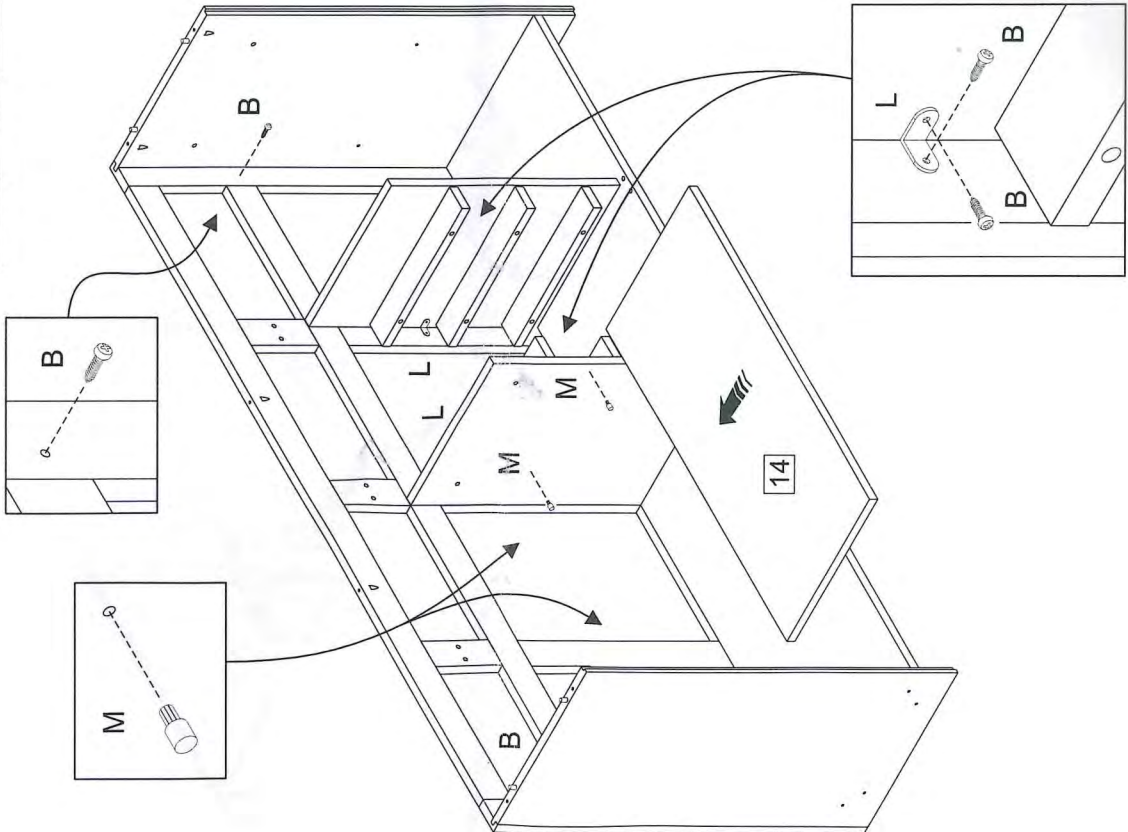

10

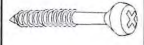
Dx3

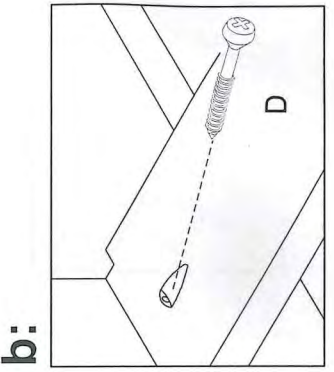
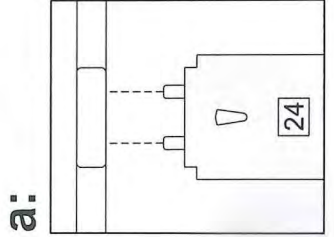
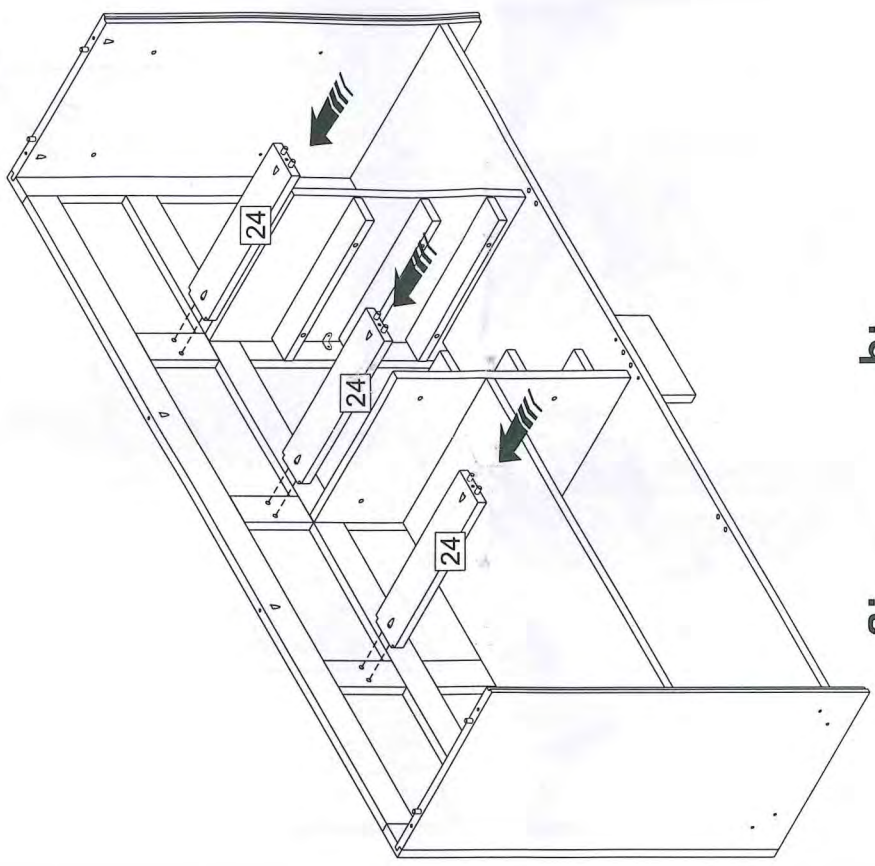
Ø4,0x35mm

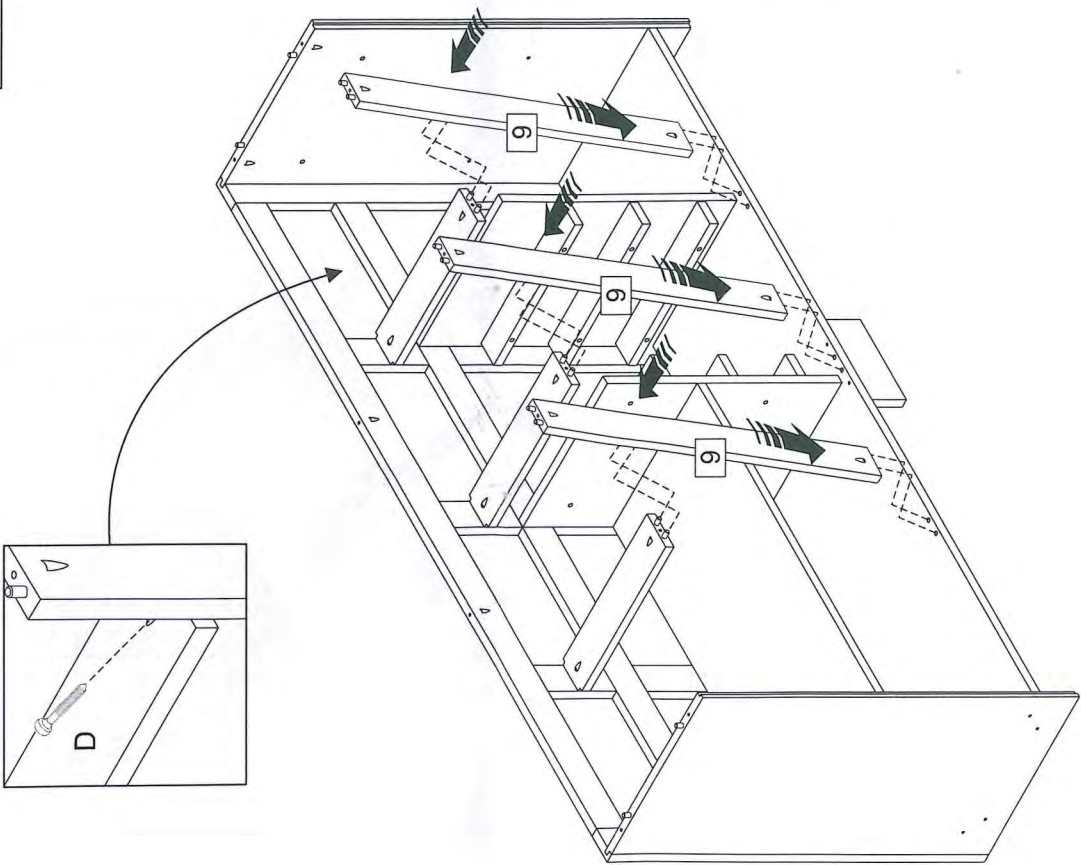

11

Dx3
Ø4,0x35mm



12

Dx12
Ø4,0x35mm

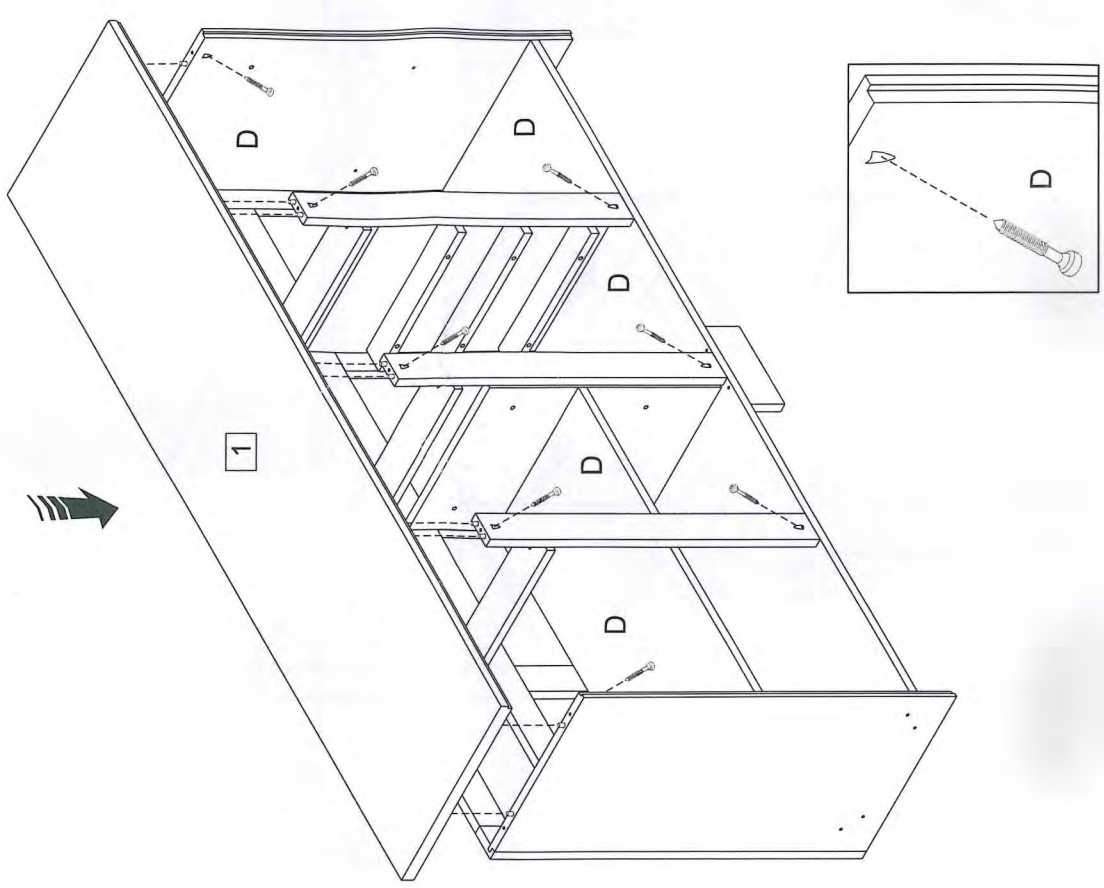

13

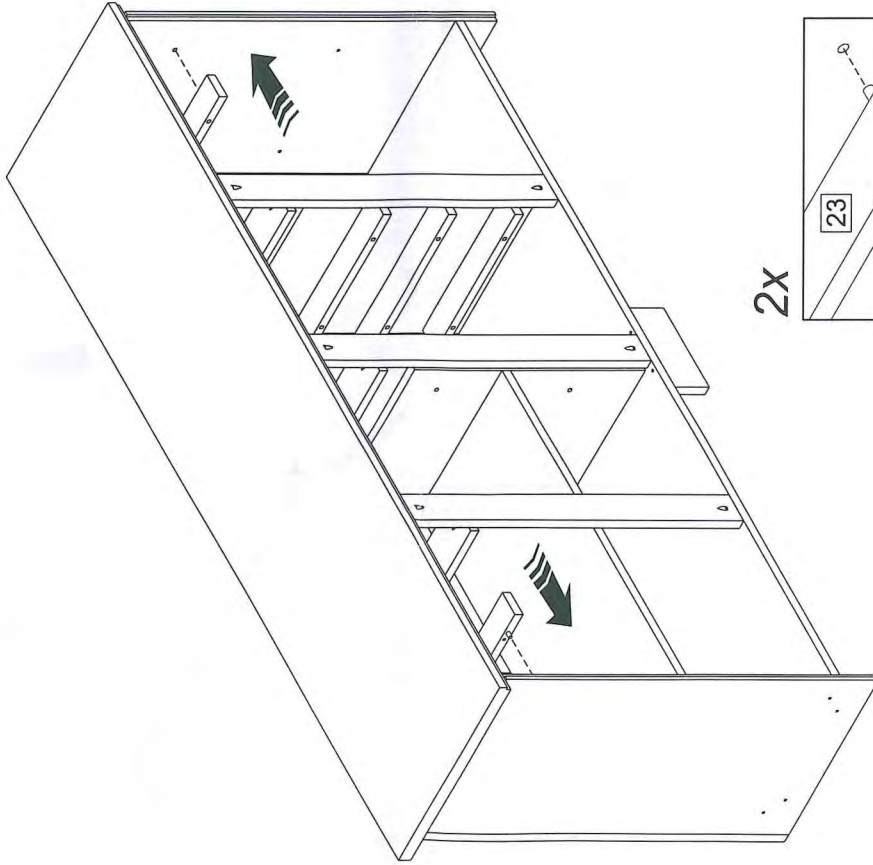
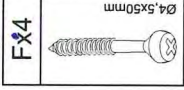

2X

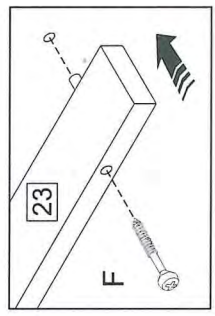

14

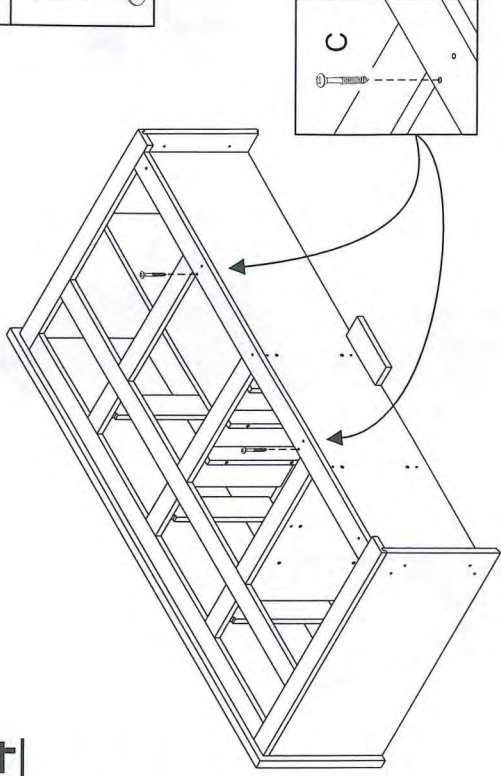
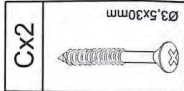

15

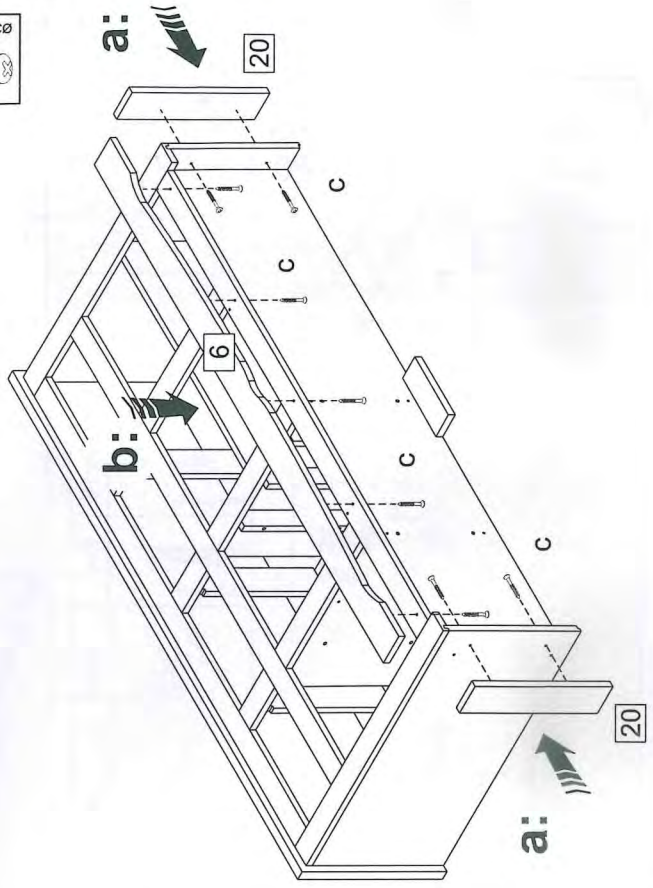
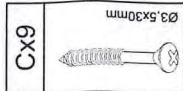

16

7x

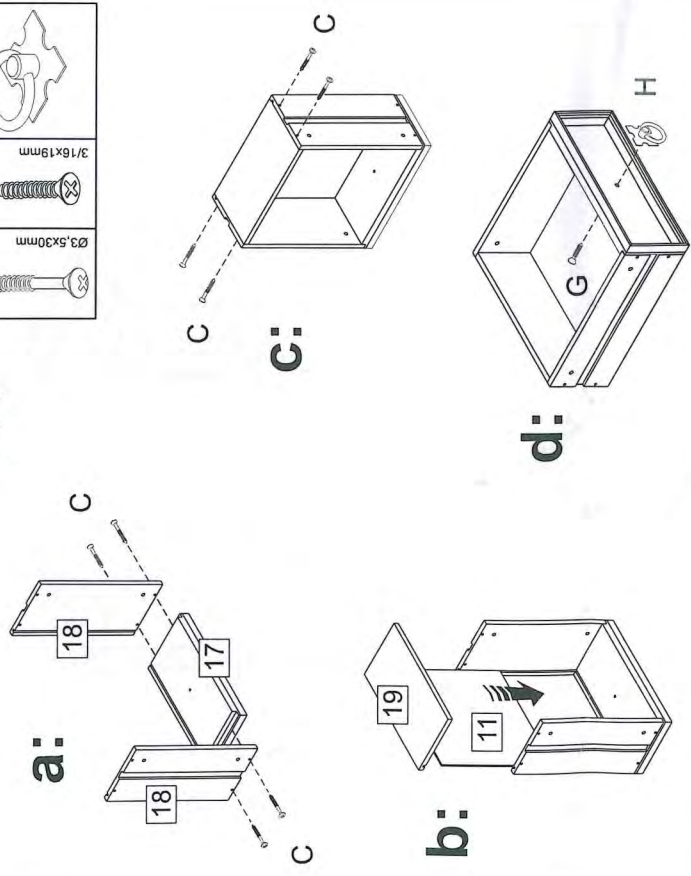

18

Bx18
 $\varnothing 3.5 \times 14 \text{ mm}$

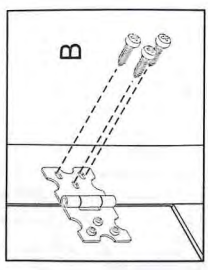
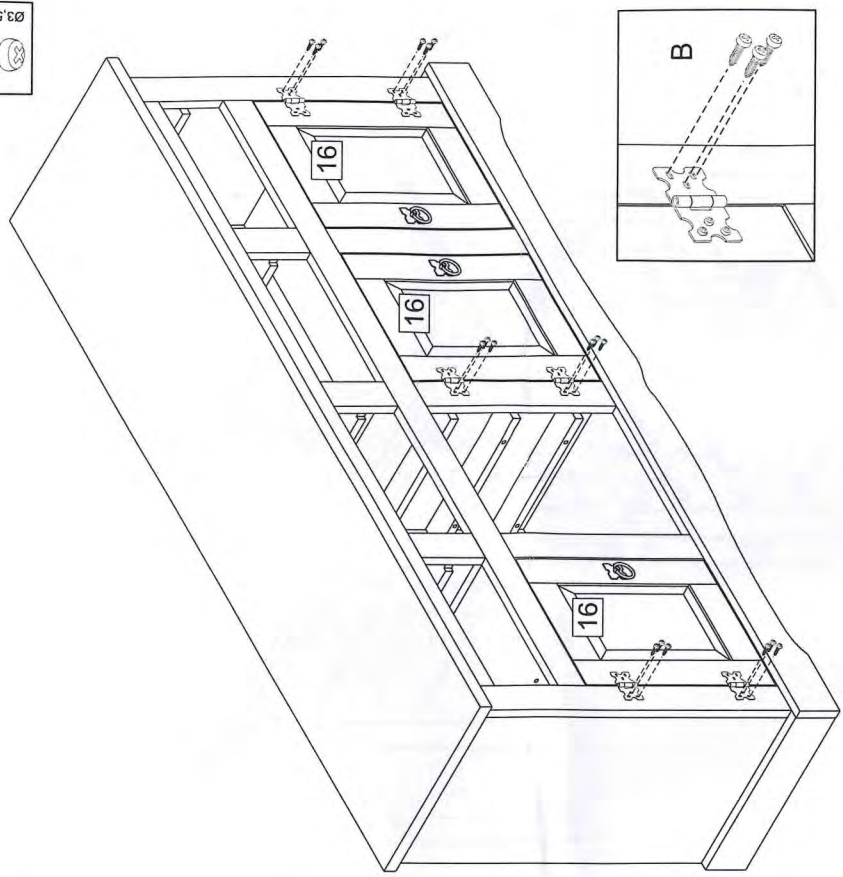

3x

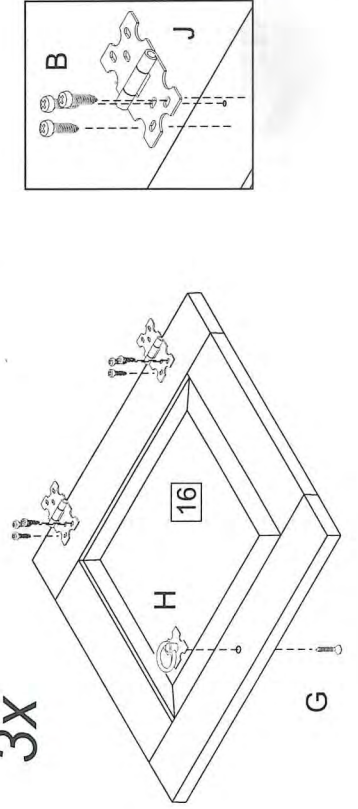

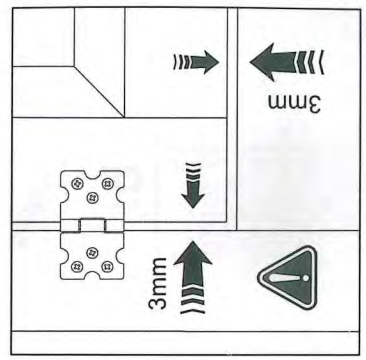
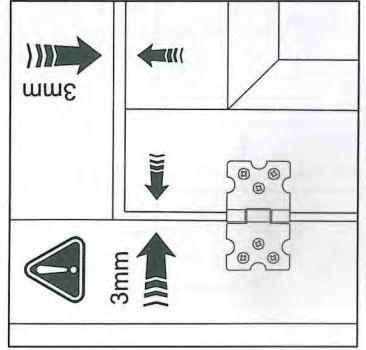

17

Bx18 $\varnothing 3.5 \times 14 \text{ mm}$
 Gx3 $3/16 \times 19 \text{ mm}$
 Hx3
 Jx6



19

Bx12	Kax3	Kbx3
		
Ø3,5x14mm		

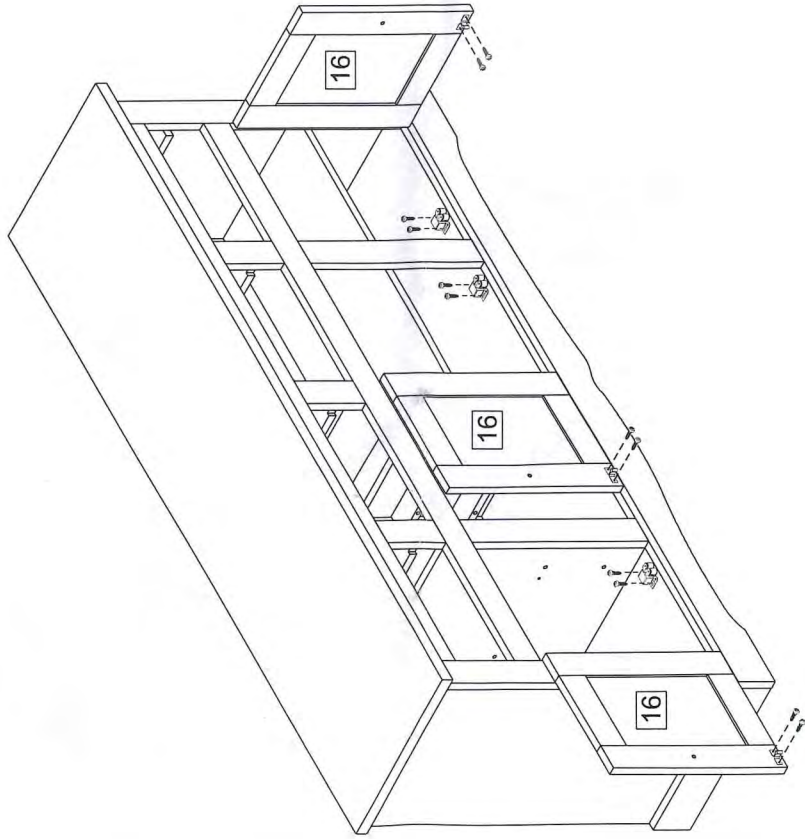

a:

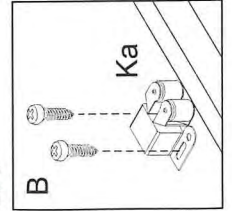

b:

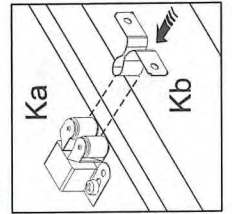

c:

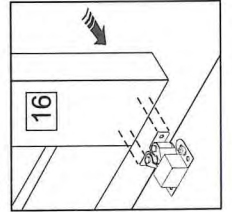

d:

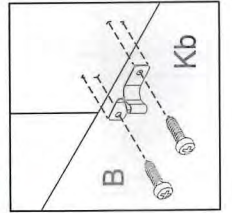

20

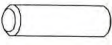
Ax14	Ø8x30mm
	

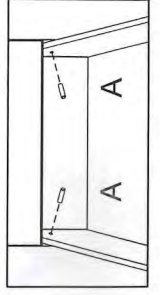
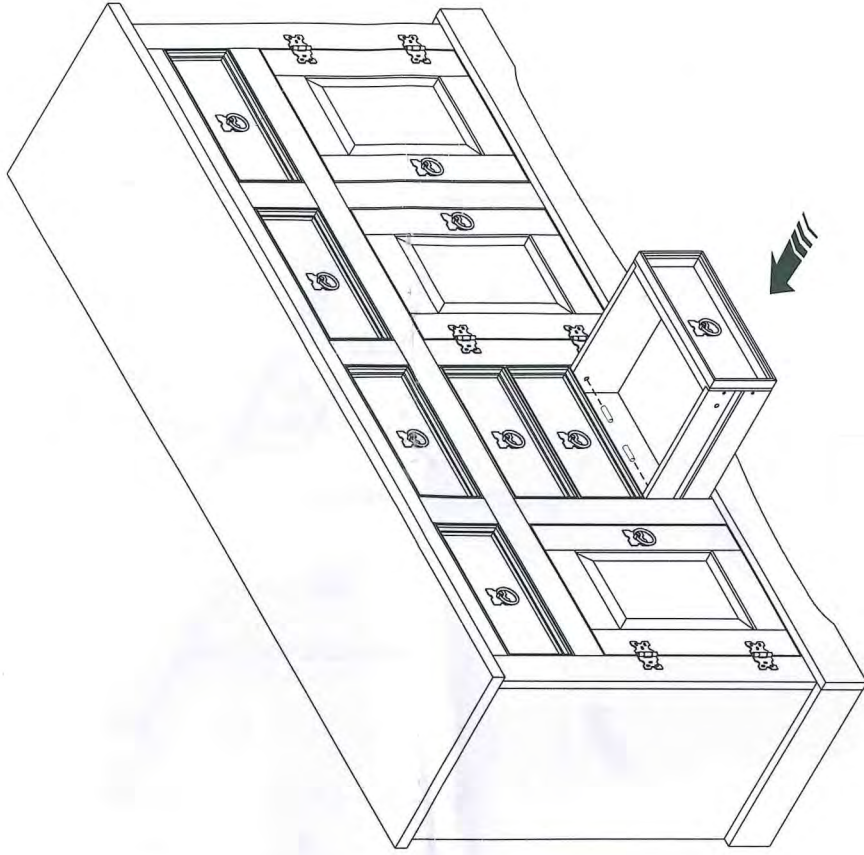

21

